



Product information  
<https://www.zenec.com/products/motorhome-infotainer/z-e3771/?lang=en>



ZENEC Software Update  
<https://www.zenec.com/support/software-updates/z-e3771/?lang=en>



**Z-E3771**

---

**INFOTAINER**

---

**OPERATING INSTRUCTIONS**

**EN**

---

ZENEC welcomes you.

**Operating instructions.**

Thank you for choosing a ZENEC Multimedia System. The more familiar you are with the ZENEC system, the better and easier you can operate it. Our request is therefore:

Please read the operating instructions before starting to use your new ZENEC system. These operating instructions contain important instructions and information for safe operation of the ZENEC system and making full use of the technical advantages of this system. They also contain various items of general information which will give you a better understanding.

At the point in time of production in the factory, the operating instructions which have been printed beforehand are the most up to date medium, and do not only apply to the ZENEC system in the original condition. Because of possible updates to the device software, deviations from the descriptions or functions of your ZENEC system and these operating instructions are possible. No claims can be derived from differing specifications, illustrations or descriptions.

Additional new information can be found in other brochures or in updated operating instructions directly on the ZENEC web site at [www.zenec.com](http://www.zenec.com) under the respective model.

If you sell your vehicle with the installed ZENEC system, please ensure that these operating instructions are in the vehicle, and that personal information such as a phone book stored in the device is deleted.

We wish you an enjoyable and safe journey.

---

**Validity of document**

This document describes the functions which were available at the point in time of printing. The functions which were introduced in follow-up versions with new software are not described in this document. You can find up to date information about the latest features via the release notes in the software installation instructions.

**ILLUSTRATIONS**

The illustrations in this document are exclusively for demonstration purposes and to provide a better understanding. Depending on the device model, the software version and the market region, slightly different information may be displayed or also shown on the touch screen of the respective ZENEC model.

**TECHNICAL DATA OF THE PRODUCT**

All technical data and descriptions contained within this document have been checked and are applicable at the time of printing. However, since continuous improvement is one of the main goals of ZENEC, we also reserve the right to make change to the hardware and software of the products at any time.

**ORIENTATION**

Certain topics are quickest to find using the table of contents. The first chapter is recommended to obtain an initial overview of the device.

**ADDITIONAL INFORMATION SOURCES**

Our Support would be pleased to reply to questions.

**INTERNET**

Device information and general information about ZENEC, e.g. regarding technology, features etc. can be found on the Internet: [www.zenec.com](http://www.zenec.com). Wherever possible, only functions have been described which are actually present in the device.

# Table of contents

<b>ZENEC WELCOMES YOU</b> .....	<b>2</b>
<b>VALIDITY OF DOCUMENT</b> .....	<b>3</b>
Illustrations .....	3
Technical data of the product .....	3
Orientation .....	3
Additional information sources .....	3
Internet .....	3
<b>TABLE OF CONTENTS</b> .....	<b>4</b>
<b>SAFETY INSTRUCTIONS</b> .....	<b>6</b>
<b>SWITCHING ON AND OFF</b> .....	<b>7</b>
<b>THEFT PROTECTION</b> .....	<b>7</b>
<b>AROUND THE FRONT OF THE DEVICE</b> .....	<b>8</b>
<b>CONNECTION TO STEERING WHEEL REMOTE CONTROL</b> .....	<b>9</b>
Multifunction steering wheel .....	9
Steering wheel remote control teach-in mode 1 – mode 1 .....	10
Steering wheel remote control teach-in mode 2 – mode 2 .....	11
<b>APP OVERVIEW LIST / HOMESCREEN</b> .....	<b>14</b>
<b>SEARCH AND BASIC ENTRY FUNCTION</b> .....	<b>14</b>
<b>CONNECTIONS</b> .....	<b>15</b>
<b>BLUETOOTH HANDSFREE DEVICE</b> .....	<b>16</b>
Control bar/toolbar (right) .....	16
Status information .....	17
Coupling - connect mobile phone via Bluetooth .....	17
Set up Bluetooth connection (coupling) .....	17
Auto Connect / Automatic connection .....	18
Device Manager .....	18
General Bluetooth settings .....	18
Call up Bluetooth settings .....	19
Accept and terminate calls .....	19
Setting up a call via the phone book .....	20
Call set-up via the numeric keypad .....	20
"Incoming call" connection view .....	20
"Outgoing call" connection view .....	21
Phone book .....	21
Contact search .....	22
Favourites .....	22
Call lists .....	23
<b>BT MUSIC – A2DP</b> .....	<b>23</b>
<b>STARTS BT MUSIC (A2DP) AUDIO PLAYBACK</b> .....	<b>24</b>
<b>MEDIA PLAYER - USB / SD / IPOD / BT MUSIC A2DP AUDIO</b> .....	<b>24</b>
<b>MEDIAPLAYER, GENERAL</b> .....	<b>24</b>
Select USB audio source .....	24
Choose between two USB sticks .....	24
Start USB audio playback .....	25
Pause and continue audio playback .....	25
Change track and fast forward / rewind .....	26
Search audio folder and file structure .....	26
Search for an audio file, e.g. track .....	26
Shuffle .....	27
Playback / repeat .....	27
Favourite list .....	27
Smart Playlist (audio playback list) .....	28
<b>VIDEO</b> .....	<b>30</b>
Select video source .....	30
Start USB video playback and search file structure .....	30
Pause and continue video playback .....	31
Change video and fast forward / rewind .....	31
Shuffle .....	31
Playback / repeat .....	32
<b>APPLE CARPLAY</b> .....	<b>32</b>
Wired connection via USB .....	32
Wireless connection via WLAN and Bluetooth .....	32
Wireless CarPlay Autostart .....	33
Operating CarPlay .....	33
<b>APPLE IPOD AUDIO (MADE FOR IPOD/IPHONE)</b> .....	<b>33</b>
Connecting iPod via USB .....	33
<b>GOOGLE ANDROID AUTO</b> .....	<b>34</b>
Wired connection via USB .....	34
Wireless connection via WLAN and Bluetooth .....	34
Wireless Android Auto Autostart .....	34
Operating Android Auto .....	35
<b>AV IN / HDMI</b> .....	<b>36</b>
<b>FM TUNER</b> .....	<b>36</b>

Call up FM Radio source .....	36
Call up station information .....	37
Change station (search, presets) .....	37
Manual station selection .....	37
FM settings .....	38
Save station .....	38
<b>TA TRAFFIC ANNOUNCEMENTS</b> .....	<b>38</b>
Activate / deactivate .....	38
Interrupt .....	39
<b>DIGITAL RADIO DAB+</b> .....	<b>39</b>
Call up DAB+ source .....	39
Call up station information .....	40
Change station .....	40
Switch ensemble .....	40
DAB settings .....	41
Save station .....	42
<b>CAMERA</b> .....	<b>42</b>
Call up camera source .....	42
Switch over camera inputs .....	42
Set and configure camera park assist lines .....	42
<b>MISC (GENERAL) SETTINGS</b> .....	<b>43</b>
<b>AUDIO SETTINGS</b> .....	<b>44</b>
Call up audio EXPERT settings .....	44
Make quick audio settings .....	45
Set EQ presets / predef. audio profile in the audio settings .....	46
Call up and set equalizer / sound settings .....	46
Set the start and source volume .....	46
Set balance and fader .....	47
Set subwoofer .....	48
Time-Alignment correction, general .....	48
Set Time-Alignment correction .....	48
<b>VEHICLE ASSISTANT SETTINGS (ASSISTS)</b> .....	<b>50</b>
Call up driver assistant settings .....	50
<b>DEVICE INPUT SETTINGS</b> .....	<b>51</b>
Call up input settings .....	51
<b>SYSTEM AND DEVICE SETTINGS</b> .....	<b>52</b>
Call up system and device settings .....	52
<b>TIME AND DATE SETTING</b> .....	<b>52</b>
Call up time and date setting .....	52
<b>TFT DISPLAY SCREEN SETTINGS</b> .....	<b>53</b>
Call up TFT display screen settings .....	53
<b>SOFTWARE VERSION</b> .....	<b>54</b>
Call up detailed version information .....	54
<b>PASSWORD PROTECTION</b> .....	<b>55</b>
Create and activate password protection .....	55
<b>NOTES CONCERNING INSTALLATION</b> .....	<b>56</b>
<b>DISASSEMBLY AND PREPARATION</b> .....	<b>56</b>
<b>OVERVIEW OF INSTALLATION AND CONNECTION ACCESSORIES</b> .....	<b>57</b>
<b>Z-E3771 CONNECTION DIAGRAM</b> .....	<b>58</b>
<b>ABBREVIATIONS</b> .....	<b>60</b>
<b>WARRANTY</b> .....	<b>62</b>
<b>CERTIFICATION / MANUFACTURER / SAFETY INFORMATION</b> .....	<b>64</b>

## Safety instructions

### ⚠ CAUTION:

Distracting the driver can lead to accidents and injuries. Operating the ZENEC system may distract the driver's attention from the prevailing traffic conditions! Connecting, changing or inserting data media may also distract the driver's attention from the prevailing traffic conditions.

### ⚠ CAUTION:

Always ensure that the volume setting allows acoustic signals from outside the vehicle to be heard at all times (e.g. signal horns or sirens).

### ⚠ CAUTION:

Incorrect assembly or start-up of the ZENEC system may result in damage to the ZENEC system or the vehicle electronics. The device should only be installed by qualified personnel who have been authorized by ZENEC.

### ⚠ CAUTION:

The ZENEC system heats up due to the active components on the pc-board when installed. The components are designed for the operating temperatures that occur, i.e. the product life and performance of the device are not affected. When uninstalling a device that was still in operation shortly before, the rear of the device with the cooling fins should be handled with due care. Depending on the operating time and the installation slot, heatsink temperatures of up to 65° C are possible, which can lead to skin burns.

If possible, allow the device to cool down for 30 minutes before unmounting. So that the back of the device with its cooling fins have cooled off to ambient temperature.

### ⚠ CAUTION:

This ZENEC system is exclusively intended for operation with an on-board voltage of 12 V DC. Operating the ZENEC system with any other on-board voltage may result in damage to the ZENEC system or to the vehicle electrical system.

### ⚠ CAUTION:

Dismantling or modifying the ZENEC system may result in damage to the device or the vehicle. Opening or modifying the device by personnel who have not been authorized by ZENEC will invalidate the warranty.

In the event of a malfunction or fault, please contact an authorized ZENEC dealer. Repairs carried out by unauthorized personnel will invalidate the warranty.

### ⚠ CAUTION:

Charging and connecting cables for external mobile devices may obstruct the driver. These should be routed so that the driver's freedom of movement is not impeded.

### ⚠ CAUTION:

Driving recommendations and traffic signs which are displayed on the ZENEC system may differ from reality. Traffic signs and traffic regulations take precedence over the driving recommendations and displays of the ZENEC system.

Please adapt your driving behaviour and speed to the respective visibility, weather, road and traffic conditions.

## Switching on and off

### Switching on and off manually Z-E3771



Pressing the Power button (Fig. S/8 ⑥), to switch the ZENEC system on and keep it pressed to switch it off again.

### Automatic on/off switching

#### Vehicles without CAN/stalk interface:

The device switches on and off automatically via the ignition.

#### Vehicles with SWC or CAN/Stalk interface connection:

The ZENEC system is activated when the vehicle ignition is switched on. The ZENEC system is switched off by turning off the ignition or removing the ignition key.

## THEFT PROTECTION

The ZENEC system is equipped with a theft protection function. If this is active, when the ZENEC system is switched on again after disconnecting the power supply, you are asked to enter a password.

To change the password:

Operating instructions → Setting → Password (Page 52)

### NOTE:

Keep the password in a safe place.  
If the password is lost, the ZENEC system must be removed and sent in to ZENEC service to have the theft protection unlocked. This service is billable!



See detailed information on page 53

\*Standard password

## Around the front of the device

The main components of the front of the device are shown and explained here. The front of the device contains various controls, including several hard keys for manually opening the source, volume up & down buttons for regulating the volume of the device, a power button for switching it on and off, and a camera button for directly access to the camera source.



Number	Symbol	Function
1	HOME	Tap to jump back to the main menu or hold down to jump to the audio settings.
2	CAM	Tap to call up the camera source. Press again to switch to camera 1 / multiview and camera 2.
3	VOICE	Tap to start the Android and CarPlay voice control. Tap once more to cancel the voice control. Tap and hold to restart the voice input.
4	+	Tap, or press and hold to increase the playback volume
5	-	Tap, or press and hold to decrease the playback volume
6	⏻	Press to mute device, press and hold to turn device ON or OFF
7	Ⓜ	Reset pin to perform hardware reset behind the cover

### Safety instruction

**⚠ WARNING:**  
Loud sound output volumes can damage hearing. Risk of injury. Do not turn up the volume too high.

## Connection to steering wheel remote control

The ZENEC system has support for the Fiat Ducato III Series 8 / 9 steering wheel remote control functions for the front and (if present) rear telephone buttons, with deviating manual assignment of several functions if required. The steering wheel buttons of the older Ducato generations are also fully supported.

### MULTIFUNCTION STEERING WHEEL

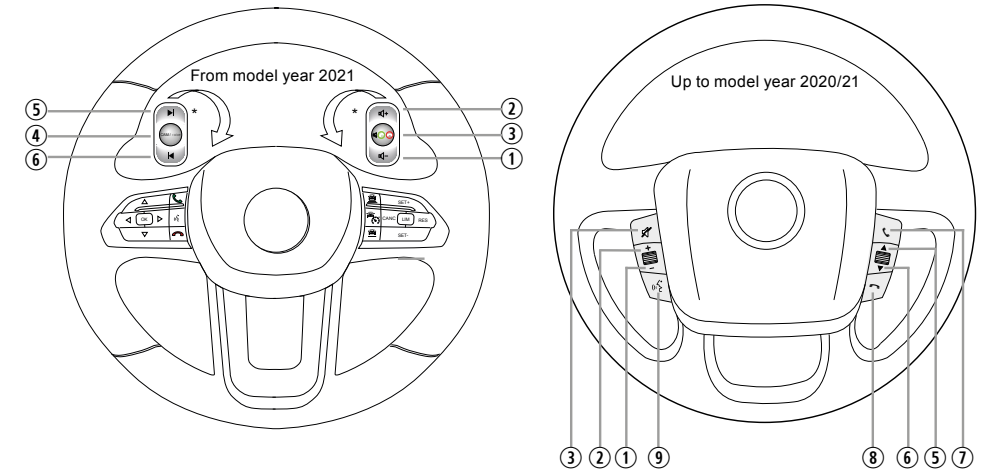

\*The rear steering wheel buttons (if present) must be directly connected via analogue LFB connection adapter cables

Number	Function with standard IR Stalk Interface	Supported by
①	Reduce volume.	Ducato Serie 7/8/9
②	Increase volume.	Ducato Serie 7/8/9
③	Mute / take and terminate additional call.	Ducato Serie 7/8/9
④	CAM/Voice	Press to call up the camera source. Hold down to start the Android Auto or CarPlay voice control. Ducato Serie 8/9
⑤	Radio source	Press to jump forward a radio station. Ducato Serie 7/8/9
	Media source	Press to jump forward a track. Hold down to start fast forwarding of the track. Ducato Serie 7/8/9
⑥	Radio source	Press to jump back a radio station. Ducato Serie 7/8/9
	Media source	Press to jump back a track. Hold down to start fast rewinding of the track. Ducato Serie 7/8/9
⑦	Accept a call.	Ducato Serie 7
⑧	Reject/terminate a call.	Ducato Serie 7
⑨	Voice	Press to start the Android Auto or CarPlay voice control, and press again to stop the voice control. Ducato Serie 7

**NOTE:** These functions are only usable if a multifunction steering wheel is present in the vehicle and the ZENEC system is connected via an analogue LFB adapter cable + LIN-BUS adapter or a vehicle-specific CAN/Stalk interface.

### STEERING WHEEL REMOTE CONTROL TEACH-IN MODE 1 – MODE 1

Fiat Ducato III Series 7 (old platform)

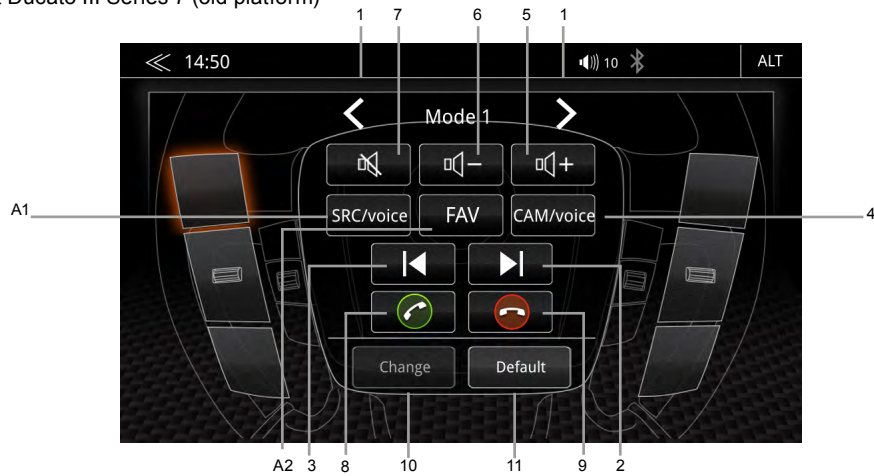

The ZENEC system is also preconfigured with a CAN-IR Stalk interfaces for vehicles in the Fiat Ducato III Series 7 platform, see compatibility list [www.zenec.com](http://www.zenec.com), but the LFB connection must be changed from "Mode 2" to "Mode 1", since Mode 2 is preset as standard in the factory settings, for direct use of new vehicles based on the Fiat Ducato III Series 8 & 9.

Number	Description / Function with analogue SWC connection
①	Mode changeover buttons: Tap to change the analogue mode. Possible settings: Mode 1 = Fiat Ducato III Series 7; Mode 2 = Fiat Ducato III Series 8 and 9.
②	Radio source: Press to jump forward a radio station. Media source: Press to jump forward a track. Hold down to start fast forwarding of the track.
③	Radio source: Press to jump back a radio station. Media source: Press to jump back a track. Hold down to start fast rewinding of the track.
④	CAM/Voice: with LFB (Key1/Key2 - mini-ISO) use: Press to call up the camera source. Press again to switch between camera 1, camera 2 and camera 3. Hold down to start the Android Auto or CarPlay voice control.
⑤	Press to increase the volume.
⑥	Press to reduce the volume.

Number	Description / Function with analogue SWC connection
⑦	Press to mute all audio sources. Press again to cancel the muting of all audio sources.
⑧	Press during an incoming call (ringing) to accept the call.
⑨	Press during an active telephone call to terminate the call.
⑩	Tap to reassign the buttons. The system deletes the current button assignments on the steering wheel.
⑪	Tap to restore the default assignments.
A1	Alternative function: Press to switch between the individual sources. Hold down to start the Android Auto or CarPlay voice control.
A2	Alternative function: Press to jump to the navigation and press again to call up the media info control bar within the navigation. Hold down to start the Android Auto or CarPlay voice control.

### STEERING WHEEL REMOTE CONTROL TEACH-IN MODE 2 – MODE 2

Fiat Ducato III Series 8 and 9

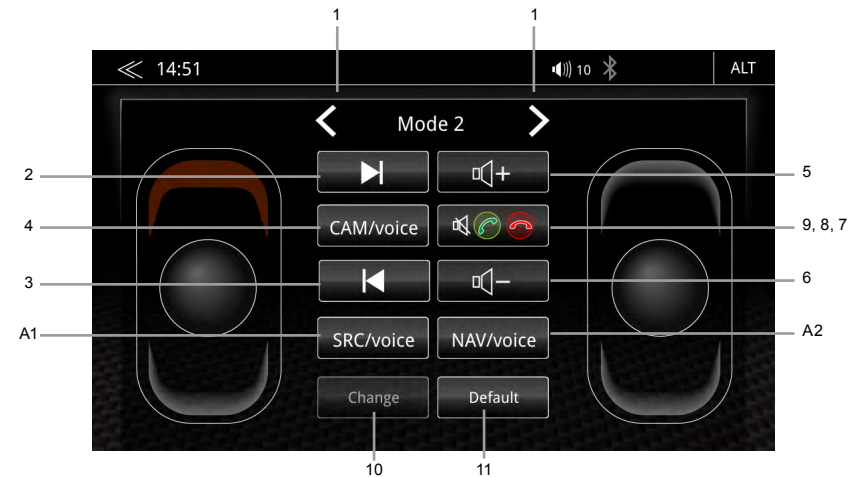

The ZENEC system is for vehicles which are already preconfigured with the CAN IR Stalk interface, see compatibility list [www.zenec.com](http://www.zenec.com). If your vehicle is equipped with a resistance-based multifunction steering wheel, you must also connect the analogue LFB adapter cable included in the scope of delivery (Page 57 - No. 2) with the main connecting cable to Key 1 / Key 2 / GND and the vehicle-side 20-pin connector. The connects the buttons on the back of the steering wheel preconfigured.

The rear LFB button functions (volume, camera, skip, BT etc.) are displayed to you visually in the system setup of the ZENEC under [Settings] → [Misc] → [LFB Assignment (Analogue)] under Mode 2. Analogue mode 2 is already preset for Series 8 and 9 in the factory. The BT handsfree telephone is connected via multiple assignment, as shown graphically in Mode 2.

Number	Description / Function with analogue SWC connection + LIN BUS Interface	
①	Mode changeover buttons:	Tap to change the analogue mode. Mode 1 = Fiat Ducato III Series 7; Mode 2 = Fiat Ducato III Series 8 and 9.
	Possible settings:	
②	Radio source	Press to jump forward a radio station.
	Media source	Press to jump forward a track. Hold down to start fast forwarding of the track.
③	Radio source	Press to jump back a radio station.
	Media source	Press to jump back a track. Hold down to start fast rewinding of the track.
④	CAM/Voice	with LFB (Key1/Key2 - mini-ISO) use: Press to call up the camera source.
		Press again to switch to camera 1 / multiview, camera 2 and camera 3. Hold down to start the Android Auto or CarPlay voice control.
⑤	Press to increase the volume.	
⑥	Press to reduce the volume.	
⑦	Mute/Accept/Hang up: Press to mute all audio sources if no call is active. Press again to cancel the muting of all audio sources.	
	Press during an incoming call (ringing) to accept the call. Press during an active telephone call to terminate the call.	
⑧	Tap to reassign the buttons. The system deletes the current button assignments on the steering wheel.	
⑨	Tap to restore the default assignments.	
A1	Alternative function: Press to switch between the individual sources.	
A2	Alternative function: Press to jump to the navigation and press again to call up the media info control bar within the navigation.	

### New assignment or teach-in of the rear buttons

1.  Call up device settings.
2. Tap on [Various] to open the settings.
3. Scroll to the end of the settings.
4. Tap on [LFB Assignment (Analogue)] to call up steering wheel operation teach-in mode 2 (Mode 2).
5. Tap [Change] to reassign the buttons. The system deletes the current button assignments on the steering wheel. The reassignment can then be started. It is advisable to assign the deleted buttons from top to bottom on the left-hand side, then repeat the procedure on the right-hand side.

### Example of reassignment:

- a. In the first step, the required function must be selected, in this case Camera (CAM). Tap on the [CAM] function symbol in the middle of the function symbol field, which has a light orange border.
- b. Press the relevant LFB button on the rear of the steering wheel (top left in this example). The system sets the camera (CAM) function to the top left LFB button and also in the virtual LFB display on your ZENEC. The camera source can be called up later by pressing the top left LFB button instead of the default setting "Skip forwards" [>I].
- c. Continue reassigning the remaining LFB buttons. Once all buttons on the LFB have been assigned, the LFB assignment can be completed. The reassignment is saved automatically, and the new configuration can be used from now on. In order to restore the defaults, tap on the "Factory setting" button. The button functions are then reset to the default values and assignments.

**i NOTE:** The front telephone and voice buttons are only connected via a LIN Bus Hybrid adapter or an optionally available CAN-IR Stalk interface "N-XFDUC8-SWC1", and cannot be changed. Whereas the rear buttons can be connected to the ZENEC via an analogue LFB cable.

**i NOTE:** The LFB buttons for driving, on-board computer and cruise control operation are directly assigned to the respective vehicle functions, i.e. the function of these buttons on the steering wheel is completely independent of the device installed in the vehicle.

**i NOTE:** A correct function can only take place if the LFB connection is set to Mode 2. [Settings] → [Various] → [LFB Assignment] → "Mode 2".

**i NOTE:** Fault-free operation of the steering wheel remote control can only be guaranteed if you use the original ZENEC accessories included in the scope of delivery. The ZENEC system and the original accessories must never be modified or altered in any way. Incorrect handling can damage the vehicle and the ZENEC system.

## App overview list / Homescreen

All sources and apps are clearly displayed in the app overview – allowing all sources/functions to be perceived at a glance and selected immediately. It is also shown which apps which are available and can be selected. The well-organized and clearly structured display makes a decisive contribution to safe operation of the device while driving.

Individually adapted sorting of the apps (sources) can be carried out using simple “Drag and Drop” operation. To do this, simply press on the app using your finger and drag it to the required position within the app overview. When the app is released, the new position is automatically taken over and stored.

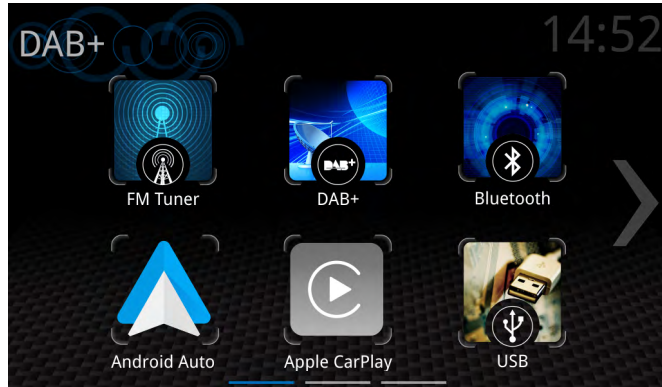

## Search and basic entry function

The ZENEC system contains a general search function which uses different sources with different search criteria. The entry keyboard is an “Android OS” operating system keyboard which is connected to the respective language system selection (Quertz / Querty).

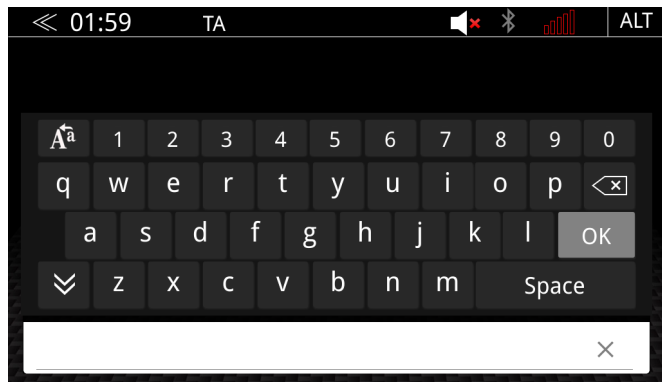

Function	Icon	Operation
Search		Cursor and text input field.
Delete		Tap to delete a number or character. Hold down to delete the entire entry.
List view		Tap to display all search results.
Open keyboard		Tap to open an entry keyboard.
Back		Tap the “X” button to end the search and go back to playback page.
Close keyboard		Tap to close the keyboard input button..

## Connections

In order to be able to use mobile devices in the vehicle, various types of connection are available. The connection type to be selected depends on the mobile device and the required function. An overview of the possible types of connection is shown below.

Function	Type of connection	Symbol
Making phone calls via the Zenec handsfree device. Phone book management and contact search.	Bluetooth	
A2DP music playback from Smartphone.	Bluetooth-Audio A2DP	
WLAN: Internet access via Smartphone/iPhone hotspot or home network (router) for future software updates.	WLAN	
USB stick: Music and video playback	USB	
Apple CarPlay App use, music and video playback, navigation and Siri voice control.	Wireless: Bluetooth and WLAN Wired: USB	 
Google Android in-car use App use, music and video playback, navigation and voice control.	Wireless: Bluetooth and WLAN Wired: USB	 
Apple iPod music playback	USB	

## Bluetooth handsfree device

The operation and use of the handsfree device is described in this chapter. All BT settings and functions of the Zenec BT system are also described.

In order to be able to use mobile devices in the vehicle via Bluetooth, a one-off Bluetooth connection between your ZENEC system and the mobile phone is required. After the one-off connection with the ZENEC system, the mobile phone is automatically detected and connected in future.

### Safety instructions

#### CAUTION:

Manual operation of the mobile phone while driving is not permitted. Only make entries or modifications via the ZENEC system if the traffic situation permits it.

#### CAUTION:







The network coverage depends on several factors – such as the network provider or the geographic situation that the vehicle is in. Tunnels, underpasses, garages or urban canyons in cities can lead to an interruption of the connection. Heat protection glazing or metal stickers on the windows of the vehicle can also interfere with the connection.

#### NOTE:

The operation of integrated information systems and communication devices while driving can distract you from the traffic conditions. You may lose control of the vehicle. Risk of accidents. Only operate the systems or devices if the traffic situation permits it. If required, stop and operate the systems or devices with the vehicle stationary.

### CONTROL BAR/TOOLBAR (RIGHT)









The control bar/toolbar with the available menu buttons for calling up the various Bluetooth sub-menus can be found in the right-hand area of the Bluetooth source. An overview of the various Bluetooth menu icons, including their functions, can be found below:

Function	Icon	Settings
Device Manager		Tap to open the device manager.
Phone book		Tap to call up the phone book of the currently coupled mobile phone.
Favourites		Tap to call up the stored favourites.
Call lists		Tap to call up the call lists.
Numeric keypad		Tap to call up the numeric keypad.
Bluetooth Settings		Tap to call up the most important Bluetooth settings directly.
Contact search		Tap to open the keyboard.

## STATUS INFORMATION

The status field which displays various items of status information in the form of symbols can be found in the status bar, in the upper section, of your ZENEC control display.

### Smartphone / iPhone symbols

Symbol	Meaning
	Mobile radio network reception strength.
	No mobile radio network available.
	Charge status or battery capacity if the currently connected mobile phone.
	Roaming active.
	Mobile phone connected.
	No mobile phone connected.
	Bluetooth sound output active.
	Bluetooth sound output deactivated.

### COUPLING - CONNECT MOBILE PHONE VIA BLUETOOTH

In order to have a Bluetooth connection (coupling) that is as problem-free as possible, the following functional prerequisites must be fulfilled.

#### Function requirements

- Compatible device with Bluetooth interface.
- ZENEC system is ready for operation.
- Bluetooth is switched on at the mobile phone.
- Bluetooth source has been selected and is being displayed
- Bluetooth pre-settings may be needed on the mobile phone, e.g. visibility, see operating instructions of device.
- For complete phone book synchronisation and display on the ZENEC system, the required permission must be granted on the mobile phone.

### SET UP BLUETOOTH CONNECTION (COUPLING)

#### 1. Active Bluetooth on mobile phone

 **INFO:** Ensure that your mobile phone is visible. You may need to remain in the Bluetooth settings of your mobile phone during the ZENEC Bluetooth device search with some mobile phone models, or set the visibility of your mobile phone in the Bluetooth settings.

#### 2. Call up Bluetooth source.

3. Start Bluetooth device search on your ZENEC system. To do this, tap the “Scan(Search) button”  in the device manager list. The Bluetooth name of your mobile phone appears in a search list of the ZENEC. Another search can be started by tapping “SCAN”.

4. Select the required mobile phone (Bluetooth name of phone) from the list and tap to “Connect icon”.

5. An ID control number is automatically displayed in a pop-up one the smartphone.
6. Confirm the respective pop-up with the ID control number on the Phone.
7. The BT device / mobile phone is connected and displayed in the ZENEC Bluetooth device list.

### AUTO CONNECT / AUTOMATIC CONNECTION

If a mobile terminal device is connected to the ZENEC system, this device is automatically connected when the ZENEC system starts up. In the event of brief disconnection, the ZENEC system will carry out another connection set-up.

**NOTE:** During initial coupling, ensure that you confirm “permanent” connection on your mobile terminal device, otherwise problems may occur during automatic connection. Ensure that you grant the relevant permission and authorisation for the contact synchronisation on your mobile phone, otherwise the phone book contacts will not be synchronised.





### DEVICE MANAGER

All BT devices that are connected or already coupled with the ZENEC system are displayed in a device list, where they can be managed.

- A maximum of 6 devices can be connected to the ZENEC system via Bluetooth. A maximum of 20 devices are recognised.

Function	Icon	Operation
Device Manager		Tap to access the device list view.

A symbol on the right next to the device name shows the type of function or use the device is being used for. An arrow symbol displayed in the direction of the Bluetooth device name shows that an active connection to the ZENEC system exists. The arrow symbol is shown in the other direction if the function of the device is inactive or not connected.

Function	Icon	Meaning
Couple		Tap to re-connect a coupled Bluetooth device.
Disconnect		Tap to disconnect a coupled Bluetooth device.
Delete		Tap to delete a Bluetooth device from the list (device must be disconnected to delete it).
Scan (Search)		Tap to search for a new Bluetooth device.

**NOTE:** The volume of the sound output with Bluetooth Audio (A2DP) depends on the device. If necessary, adjust volume setting on Bluetooth device.



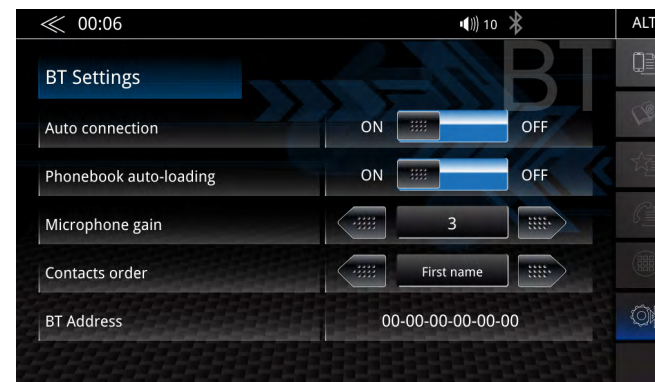

### GENERAL BLUETOOTH SETTINGS

All basic settings for Bluetooth operation can be made in the Bluetooth setting. In order to make the required settings, tap the respective field or symbol.

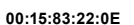

### CALL UP BLUETOOTH SETTINGS.

1. Call up Bluetooth source.
2. Tap on  in the Bluetooth control bar/toolbar to call up the Bluetooth settings.
3. Make the required settings. The changes are taken over automatically.

Setting	Icon	Operation
Automatic connection		ON / OFF.
Order		1. Sort according to first name of contact. 2. Sort according to surname of contact.
Microphone amplification gain		Tap for fine setting of microphone amplification factor from 0 to 6.
Bluetooth Address		Unique ZENEC BT device address.
Phone book auto-sync		ON / OFF (automatically download address book).

**NOTE:** In isolated cases a restart of your ZENEC system will be required, e.g. if the microphone settings have been changed.

### ACCEPT AND TERMINATE CALLS

Incoming calls can be accepted in different ways depending on the configuration of the vehicle in combination with the ZENEC system and interface / analogue SWC (Key 1 / Key 2) and the LIN bus connection.

#### Accept call

Option 1: Via the ZENEC system, by tapping  "Accept"

Option 2:  Press the relevant button on the front / rear of the steering wheel.

## Reject call

Option 1: Via the ZENEC system, by tapping  "Reject"



Option 2:  Press the relevant button on the front / rear of the steering wheel.

## End call



Option 1: Via the ZENEC system, by tapping  "End call"

Option 2:  Press the relevant button on the front / rear of the steering wheel.

## SETTING UP A CALL VIA THE PHONE BOOK

1. Call up Bluetooth source.
2. Tap on  in the Bluetooth control bar/toolbar to open the phone book.
3. Select required contact and tap on the number of the handset symbol .
4. Now the screen switches to the "outgoing call" connection view and the connection is set up via the mobile phone to which the telephone function has been assigned.

## CALL SET-UP VIA THE NUMERIC KEYPAD

1. Call up Bluetooth source.
2. Tap on  in the Bluetooth control bar/toolbar to open the keypad.
3. Enter the full required telephone number using the keypad.
4. Tap on  to set up the connection.
5. Now the screen switches to the "outgoing call" connection view and the connection is set up via the mobile phone to which the telephone function has been assigned.

## "INCOMING CALL" CONNECTION VIEW

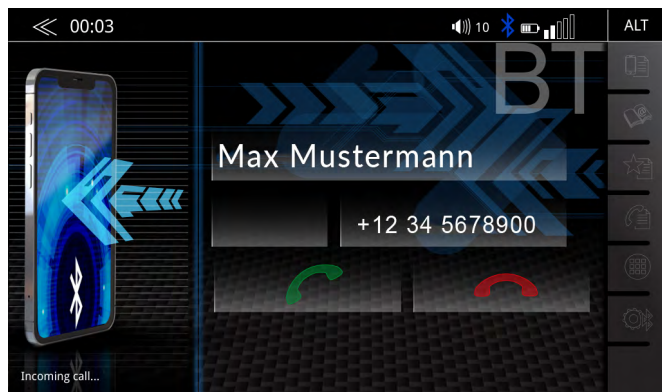

## "OUTGOING CALL" CONNECTION VIEW

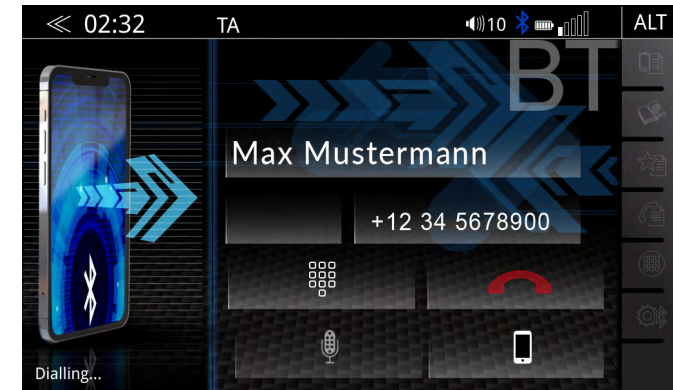

**NOTE:** The name of the incoming call is exclusively displayed if the number of the caller is stored in the phone book and also transferred by the network operator. Otherwise only the phone number is displayed.  
Calls which are carried out via the handsfree device can be continued on the mobile phone and vice-versa.

## PHONE BOOK

The contacts are transmitted after successful coupling of the mobile phone and displayed in sorted order. Required favourites can also be created directly in the phone book. Contact pictures cannot be displayed, even if the function is supported by the mobile phone. Also, contacts can only be created and edited on the mobile phone, which requires subsequent re-synchronisation.

Entire phone book display (display all contacts)

1. Call up Bluetooth source.
2. Tap on  in the Bluetooth control bar/toolbar to call up the phone book.
3. The contacts are listed in alphanumeric order. The sorting order can be changed in the Bluetooth settings. Possible settings are sorting "By contact name" or "By surname". The contact search is provided depending on the number of contacts.

**NOTE:** Depending on the number of existing Smartphone and phone book entries, the initial synchronisation can take several minutes.  
A maximum of 1000 contacts per coupled Smartphone can be synchronised; it does not matter whether the contacts are in the phone book or stored on the SIM card.  
In order to be able to use the phone book or call lists without problems, please ensure that you confirm the data access approval on the Smartphone during the coupling process. It is advisable to confirm this permanently on the Smartphone.  
The contact names can be displayed in a different order. Depending on how the contacts are stored on the mobile phone, the sorting of the contacts may differ from the sorting that was selected.

## CONTACT SEARCH

The contact search is available after successful synchronisation.

1. Tap on Search  on the Bluetooth control bar/toolbar to call up the contact search window.
2. Enter letters using the keyboard.



 **INFO:** The list of hits is displayed beneath the input field.

3. Tap on [ok] to display the entire list.
4. Select contact to have it displayed, including the phone numbers.
5. The connection to the mobile phone is set up by tapping the number or the telephone handset .



## FAVOURITES

You have the possibility of saving up to 8 or more phone numbers in a favourite list and retrieving them. You can mark and save all phone numbers stored in the phone book as favourites, except for e-mails and addresses.

Add phone number to list of favourites:

1. Call up Bluetooth source.
2. Tap on  in the Bluetooth control bar/toolbar to call up the phone book.
3. Select required contact and display all saved phone numbers for the contact by tapping on "+".
4. Tap on  to add the phone number to the favourites. Tap on  again to remove the phone number from the favourites.

Another way of deleting a phone number from the favourites:

1. Call up Bluetooth source.
2. Tap  on the Bluetooth control bar/toolbar to call up the favourites.
3. Tap  to delete the required phone number from the favourites.

## SETTING UP A CALL VIA FAVOURITES

1. Call up Bluetooth source
2. Tap  on the Bluetooth control bar/toolbar to call up the favourites.
3. Tap on required phone number.
4. Now the screen switches to the "outgoing call" connection view and the connection is set up via the mobile phone to which the telephone function has been assigned.

 **NOTE:** All of the stored favourites are visible to every coupled participant, since they are stored on the device.  
A change to the data on the mobile phone is not automatically taken over into the favourites. If data such as telephone numbers is to be changed, they must be transferred into the favourites again.



## CALL LISTS

The last outgoing, missed and incoming calls are synchronised from the mobile phone with the ZENEC handsfree device. This procedure can take several minutes depending on the number of contacts. The transmission only takes place from the currently coupled mobile phone.

Display all call lists:

1. Call up Bluetooth source.
2. Tap on  in the Bluetooth control/operating list to call up the call list overview. The following call lists are displayed:
  - Missed calls
  - Accepted calls
  - Outgoing calls

Tap on the "+" symbol to display the detailed call list. A symbol following the respective list also shows what kind of call list it is.

Function	Symbol	Meaning
Missed calls		This symbol indicates that the calls have been missed and could not be accepted. Entries with this symbol designate calls in absence.
Accepted calls		This symbol indicates that the calls are incoming and have been accepted. Entries with this symbol designate accepted calls.
Outgoing calls		This symbol indicates that the calls are outgoing. Entries with this symbol designate outgoing calls. Only the entered numbers can be seen in the list.

## BT Music – A2DP

The A2DP (Advanced Audio Distribution Profile) BT connection permits an audio signal such as music to be transmitted in stereo quality via Bluetooth. This makes it possible for Media Player control elements such as Play, Pause and Skip from coupled terminal devices which are in audio playback mode to be used via the ZENEC. The display of iD3 Tag metadata is only possible if this is present on the tracks streamed via the Smartphone.

### Function requirements

- Compatible device with Bluetooth interface.
- ZENEC system is ready for operation.
- Existing Bluetooth connection (coupling) between ZENEC and the Bluetooth device such as a Smartphone etc.

## Starts BT Music (A2DP) audio playback

1. Select via the app overview page [Home] → “BT Music”. Tap the source to call up the playback page of the BT Music Media Player.
2. Playback starts automatically after calling up the BT Music source.
3. Tap on Skip forward/back to play the next or previous track.





**NOTE:** The functions specified here are always dependent on the connected mobile terminal device, its software version and the level of support.

## Media Player - USB / SD / IPOD / BT Music A2DP AUDIO

Be it a music track, audio books, film music or podcasts: The ZNEEC system can play many of the digital audio media formats via the two powerful USB 2.0 interfaces. The audio output takes place via the vehicle speakers. Various sound settings and sound optimisations can be made in the audio settings and stored in a user profile (personalised).

**NOTE:** Playable formats: A detailed overview of all supported A/V file formats can be found on the ZNEEC web site [www.zenec.com](http://www.zenec.com) under the respective device model.

The following USB audio sources can be used:

Symbol	Meaning
	USB stick.
	Apple iPod.
	Google Android Auto (cable bound via USB or wireless).
	Apple CarPlay (cable bound via USB or wireless).

## MediaPlayer, general

All of the MP3 tag metadata information from the music collection, such as artist, album name, genre or track name is transmitted to the ZNEEC system and identified in order to use it as a basis for creating an internal media database. This can take some time depending on the USB device, the file size, the number of sub-folders and the number of tracks.

### SELECT USB AUDIO SOURCE

1. Plug USB device into USB connection.

**INFO:** It is best to use the USB extension cable included in the scope of delivery.

2. Select via the app overview page [Home] → “USB device source”. Tap the source to call up the playback page of the Media Player.

### CHOOSE BETWEEN TWO USB STICKS

1. Plug the USB sticks into the USB connections.

**INFO:** It is best to use the USB extension cable included in the scope of delivery.

2. Select via the app overview page [Home] → “USB source”. Tap the USB source symbol to call up the playback page of the USB Media Player.

3. Call up the playback list / file directory (playlist page).

Tap the List symbol  to call up the file directory of the USB stick.

4. Switch to the main directory of the USB stick.

Tap and press on the currently displayed folder for 3 sec. (folder name) to switch directly to the main directory of the USB stick.

5. Select and tap the required USB stick or the name of the USB device.

**NOTE:** After a USB source has been selected, the information about the current track or playback file is displayed on the ZNEEC system. The content and scope depends on the selected audio source.

### START USB AUDIO PLAYBACK





1. Call up USB device source.

2.  Call up the playback list / file directory (playlist page).

3. Search music collection or folder.

4. Select required track and tap to start playback. Starting with the selected track, every track in the playback list or the audio files in the folder are played back.



The symbols on the left next to the respective track information line show what type of information it is:

Function	Symbol	Meaning
Artist		Information about the artist.
Track		Information about the track.
Album		Information about the album.
Genre		Additional information such as Genre.

### PAUSE AND CONTINUE AUDIO PLAYBACK





On the ZNEEC device:

Tap on the following button to pause or continue the playback.

Function	Symbol	Meaning
Playback		Tap to play back the track.
Pause		Tap to play back the track.

## CHANGE TRACK AND FAST FORWARD / REWIND

On the ZENEC device:

Function	Symbol	Meaning
Back		Tap to skip back a track. Hold down to start fast rewind.
		Wipe to the left to skip back a track.
Forward		Tap to skip forward a track. Hold down to start fast forward.
		Wipe to the right to skip forward a track.

On the steering wheel remote control of the vehicle:

In vehicles with Skip buttons ① on the steering wheel with a suitable interface or the analogue SWC connection, the change track and fast forward/rewind function is also supported.

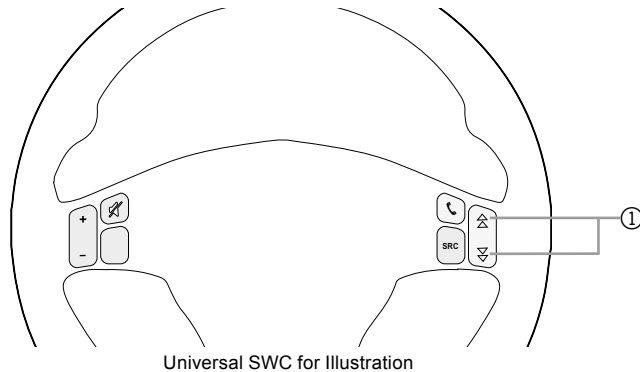

## SEARCH AUDIO FOLDER AND FILE STRUCTURE

- ☰ Call up the playback list / file directory (playlist page).
- Search music collection or folder.
- Tap on required folder to display the contents of the folder such as the track or other sub-folders.
- Select required track and tap to start playback. Starting with the selected track, every track in the playback list or the audio files in the folder are played back one after the other.

## SEARCH FOR AN AUDIO FILE, E.G. TRACK

The possible search criteria depend on the selected audio source. When the sequence of characters and letters has been entered, the entire music collection of the USB device is searched.

Start search:

- USB source "Playback page".
-  Select "Media search".

3. Enter required sequence of characters or letters, track name, artist etc.

4. The result of the search is displayed beneath the input field.

**INFO:** All search results are displayed for which track information containing the entered sequence of character or letters exists. The more characters or letters are entered, the more restricted the result is.

5. Tap on [OK] to display the entire list.

**INFO:** Tap on the input field to open the keyboard again.

6. Tap on required track from the result list to start playback.

**NOTE:** The search criteria relate to the metadata stored in the track information.

## SHUFFLE

Shuffle principle: All tracks in the entire music collection of the selected audio source are played back in random order.

Shuffle off:

- USB source "Playback page".
-  Tap to perform a "shuffle". Tap again to end the shuffle.



## PLAYBACK / REPEAT

Principle of playback repeat: There are three kinds of possible repeats, a track, the entire folder with music or the entire music collection is automatically played back repeatedly.

Select playback repeat:

- USB source "Playback page".
-  Tap to carry out the required "Repeat type".

The following repeat types can be selected:

Function	Symbol	Meaning
Repeat track		Repeat a music track.
Repeat folder		Repeat the entire folder with music.
Repeat all		Repeat the entire music collection of the selected audio source.

## FAVOURITE LIST

Favourite list principle: The current track can be simply and quickly added to a personal favourite playback list. If the current track is already in the favourite list, it can be easily and conveniently deleted from it again. The favourite list can be called up at any time via the playlist / playback list page.

Call up favourite list:

- USB source "Playback page".

2.  Switch to “Playlist page”.

3.  Call up “Favourite list”.

Add track to favourite list:

1. USB source “Playback page”.

2.  Tap to “Add to favourites” or “Delete from favourites”.





Delete track from favourite list:

1.  Switch to “Playlist page”.

2.  Call up “Favourite list”.

3.  Tap to “Delete from favourite list”.

A symbol  at the bottom in the media operating list shows whether the current track has already been added to the favourite list. If the symbol appears in red, the track is present in the favourite list. The symbol is shown in grey is the track is not in the favourite list.

Function	Symbol	Meaning
Track added to “Favourite”		Current track already added to favourite list.
Track not added “Not favourite”		Current track is not in the favourite list.
Favourite list		Display Favourite list.
Add track		Add a track to the favourite list (Not possible with BT Music and iPod).
Delete track		Delete a track from the favourite list (Not possible with BT Music and iPod).

### SMART PLAYLIST (AUDIO PLAYBACK LIST)

Create a playlist for a road trip or in accordance with your own requirements. You can also manage the playlists created using the Smart Playlist function. The playlists can be given their own names.

Call up Smart Playlist overview:

1. USB source “Playback page”.

2.  Switch to “Playlist page”.

3.  Call up “Smart Playlist”.

Create playlist and add a track:

1. USB source “Playback page”.

2.  Open Smart playlist window.

3. Tap on “New playlist”.

4. Enter a name for the playlist and tap on [OK].

5. Re-tap to the smart playlist window icon.

6. Tap the name of the previously created playlist to add the song.

 **INFO:** A system pop-up appears with the information that the track has been added.

Add title to existing playlist:

Once a playlist has been created, tracks can be quickly and easily added without further intermediate steps.

1. USB source  “Playback page”.

2.  Open Smart playlist window.

3. Tap on the name of the required playlist to add the track.

 **INFO:** A system pop-up appears with the information that the track has been added.

Delete or rename playlist:

1. USB source  “Playlist page”.

2.  Call up “Smart Playlist”.

3. Tap on edit “+”.

4. Tap on “Delete”, “Rename” or “Abort” to carry out “Delete from playlist”, “Rename” or “Cancel Edit” for the required track.

Additional steps with “Rename”:

5. Enter a new name for the playlist and tap on “OK” .

6. Check entry and confirm with “OK” again to take over the new name.

Delete track from a playlist:

1. USB source  “Playlist page”.

2.  Call up “Smart Playlist”.

3. Tap on name of playlist to display it.

4. Tap on edit “+”.

5. Tap on “Delete” to “Delete required track from playlist”.

 **INFO** Tap on “Cancel” to cancel all procedures and changes.

Move track:

1. USB source  “Playlist page”.

2.  Call up “Smart Playlist”.

3. Tap on name of playlist to display it.

4. Tap on edit “+”.

5. Tap on “Move” to more the required track into another playlist.







 **INFO** Tap on “Cancel” to cancel all procedures and changes.

## VIDEO

Be it films, YouTube videos or music videos: The ZENEC system can play many of the digital video files via the two USB interfaces, HDMI or AV IN. The audio output takes place via the vehicle speakers. Various sound settings and sound optimisations can be made in the audio settings and stored in a user profile (personalised).

Playable formats: A detailed overview of all supported A/V file formats can be found on the ZENEC web site [www.zenec.com](http://www.zenec.com) under the respective device model.

The following video sources can be used:

Symbol	Meaning
	USB stick.
	Apple iPod.
	Google Android Auto (cable bound via USB or wireless).
	Apple CarPlay (cable bound via USB or wireless).
	HDMI.
	AV IN.



**NOTE:** The playing of video files while driving is not permitted by law. For this reason, the screen is switched off while the vehicle is moving.

### SELECT VIDEO SOURCE



1. Connect video source / device to USB, HDMI or AV IN connection.
2. Select via the app overview page [Home] → "Video device source". Tap the required source to call up the playback page of the Media Player.

**NOTE:** After a video source has been selected, the information about the current video or playback file is displayed on the ZENEC system. The content and the scope depend on the selected video source.

### START USB VIDEO PLAYBACK AND SEARCH FILE STRUCTURE

1.  Switch from audio playback to video playback.  
Tap the symbol again to switch back to audio playback.
2.  Call up the video playback list / file directory (video playlist page).
3. Search video collection or list.
4. Select required video file and tap to start playback. Starting with the selected video, all videos in the playlist are played one after the other.



The symbols on the left next to the respective video file name show whether it is a video or audio file.

Symbol	Meaning
	Video file.
	Audio file.
	Indicator of current playback.

### PAUSE AND CONTINUE VIDEO PLAYBACK



On the ZENEC device:

Tap on the following button to pause or continue the playback.

Function	Symbol	Meaning
Playback		Tap to play back the track.
Pause		Tap to play back the track.

### CHANGE VIDEO AND FAST FORWARD / REWIND

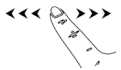
On the ZENEC device:

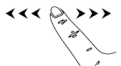
Function	Symbol	Meaning
Back		Tap to skip back a video. Hold down to start fast rewind.
		Wipe to the left to skip back a video.
Forward		Tap to skip forward a video. Hold down to start fast forward.
		Wipe to the right to skip forward a video.

On the steering wheel remote control of the vehicle:

In vehicles with Skip buttons on the steering wheel with a suitable interface or the analogue SWC connection, the change track and fast forward/rewind function is also supported.

### SHUFFLE

Shuffle principle: All tracks in the entire music collection of the selected video source are played back in random order.

Shuffle off:

1. USB source “Playback page”.
2.  Tap to perform a “shuffle”.



### PLAYBACK / REPEAT

Principle of playback repeat: There are two types of possible repeat for automatic repeated playback of a video or the entire video collection.

Select playback repeat:

1. USB source “Playback page”.
2.  Tap to carry out the required “Repeat type”.

The following repeat types can be selected:

Function	Symbol	Meaning
Video repeat		Repeat first video.
Repeat all		Repeat the entire video collection of the selected video source.

## APPLE CARPLAY

With Apple CarPlay you can operate certain functions and online services of a compatible Apple iPhone via the Siri voice operation and intuitively via the ZENEC screen.

### Prerequisite:

- Before you couple your phone with your ZENEC system, ensure that Siri is enabled. If Siri is not activated on the phone, select [Settings] → [Siri & Search] and one of the following options to activate:
  - › “Press side button for Siri” (on an iPhone with Face ID – newer models)
  - › “Press Home button for Siri” (on older iPhone models)

### WIRED CONNECTION VIA USB

1. Connect a compatible iPhone to the USB-1 connection on the rear of your ZENEC device using an Apple Lightning cable.
2. Unlock iPhone.
3. Apple CarPlay is coupled and the CarPlay Home screen is automatically displayed.
4. If the CarPlay home screen is not automatically displayed:  
[Home] Call up the app overview list.
5. Tap on the CarPlay source symbol  in the app overview list of your ZENEC device to select the CarPlay source.

### WIRELESS CONNECTION VIA WLAN AND BLUETOOTH

#### Commended variant:

1. Activate the mode for wireless coupling via Bluetooth and WLAN on your iPhone.
2. Tap on the “CarPlay source icon” to open the Bluetooth and Wifi device search page.

3. Confirm the pop-up.

4. Tap on “Add new” to start the Bluetooth device search on your ZENEC system. The Bluetooth name of your iPhone appears in a small search list of the ZENEC.
5. Select the required iPhone (Bluetooth name of phone) from the list and tap to “Connect icon” in the front of the phone name.
6. An ID control number is automatically displayed in a pop-up one the iPhone.
7. Confirm the respective pop-up with the ID control number on the iPhone.
8. Confirm the use of CarPlay on the iPhone by tapping on “Allow”.
9. Apple CarPlay is coupled and the CarPlay Home screen is automatically displayed.

### WIRELESS CARPLAY AUTOSTART

If an iPhone has been successfully connected, your iPhone will automatically connect wirelessly with CarPlay when the next trip takes place.

### OPERATING CARPLAY

CarPlay can be operated via the ZENEC screen and the Siri voice control.

1.  Press the Voice button on the steering wheel or the [Voice] button on the front of the device to activate or call up the Siri voice control on the iPhone.
2. Speak the commands which are known by the iPhone.

**NOTE:** ensure that you grant the various permissions and authorisations on your iPhone, otherwise some of the CarPlay functions will not be properly supported.

Ensure that you grant the relevant permission and authorisation for the CarPlay contact synchronisation on your mobile phone, otherwise the phone book contacts will not be synchronised.

CarPlay may not be available depending on the country variant. Please check out the Apple web site for more information.

CarPlay and the associated apps are made available from the iPhone. The scope and content depend on the app provider and can vary depending on the country variant.

## APPLE IPOD Audio (Made for iPod/iPhone)

MFI compatible, simply and conveniently connect your Apple device to your ZENEC system using a suitable cable.

### CONNECTING IPOD VIA USB

1. Ensure that the iPod mode is activated on your ZENEC device. [Setting] → [Misc] → Apple Connectivity “iPod” (default CarPlay mode).
2. Connect a compatible iPod touch to the USB-1 connection on the rear of your ZENEC device using an Apple Lightning USB cable.
3. Unlock iPod.
4. [Home] Call up the app overview list.
5. Tap on the iPod source symbol  in the app overview list of your ZENEC device to select the iPod source.

For more explanations and information about iPod operation on the ZENEC system, please refer to chapter USB / SD / iPod / BT-A2DP AUDIO.

---

## GOOGLE ANDROID AUTO

With Google Android Auto you can access compatible apps and online services from your Android Smartphone in your vehicle and intuitively operate them via the screen of your ZENEC device or the Google Voice Assistant.

### Prerequisite:

- Download the Android Auto App from the Google Play Store.
- Ensure that the GPS location services are activated on your Smartphone.
- In order to carry out an initial start-up, the vehicle must be stationary and the handbrake must be applied.
- The Android Smartphone must be coupled with the ZENEC device via Bluetooth beforehand in order to use the handsfree function of Android Auto.

### WIRED CONNECTION VIA USB

1. Connect a compatible Android Smartphone to the USB-1 connection on the rear of your ZENEC device.
2. Follow the dialogues on the screen of the Smartphone and the ZENEC device to set up Android Auto and configure the starting behaviour. The selected starting behaviour can also be changed later in the Smartphone device settings [Device Settings] → [Various] → “Android Auto - Autostart” On/Off.
3. After successfully completing the initial start-up, the Android Auto user interface automatically appears on the screen of the ZENEC device.  
If the Android Auto home screen is not automatically displayed:
4. [Home] Call up the app overview list.
5. Tap on the Android Auto source symbol  in the app overview list of your ZENEC device to select the Android Auto source.

### WIRELESS CONNECTION VIA WLAN AND BLUETOOTH

1. Activate the mode for wireless coupling via Bluetooth and WLAN and the GPS location services on your Android Smartphone.

 **INFO:** Make sure that your mobile phone is visible. You may need to remain in the Bluetooth settings of your mobile phone during the ZENEC Bluetooth device search with some Smartphone models, or set the visibility of your mobile phone in the Bluetooth settings.

2. Tap on the “Android Auto source icon” to open the Bluetooth and Wifi device search page.
3. Confirm the pop-up.
4. Tap on “Add new” to start the Bluetooth device search on your ZENEC system. The Bluetooth name of your Phone appears in a small search list of the ZENEC.
5. Select the required Smartphone (Bluetooth name of phone) from the list and tap to “Connect icon”.
6. An ID control number is automatically displayed in a pop-up one the smartphone.
7. Confirm the respective pop-up with the ID control number on the Phone.
8. Android Auto is coupled and the Android Auto Home screen is automatically displayed.

### WIRELESS ANDROID AUTO AUTOSTART

If an Android Smartphone has been successfully connected, your Smartphone will automatically connect wirelessly with Android Auto when the next trip takes place.

---

## OPERATING ANDROID AUTO

Android Auto can be operated via the ZENEC screen and the Google Voice Assistant.

1.  Press the Voice button on the steering wheel or the [Voice] button on the front of the device to activate or start up the Google Voice Assistant on the Smartphone.
2. Speak the commands which are known by the Google.

### NOTE:

Ensure that you grant the various permissions and authorisations on your Smartphone, otherwise some of the Android Auto functions will not be properly supported.



Ensure that you grant the relevant permission and authorisation for the contact synchronisation on your mobile phone, otherwise the phone book contacts will not be synchronised.

Android Auto may not be available depending on the country variant. Please check out the Android Auto web site for more information.

Android Auto and the associated apps are made available by Google. The scope and content depend on the app provider and can vary depending on the country variant.

## AV IN / HDMI

You can connect a DVD player, BluRay player, hard drive recorder, laptops, games consoles, an HDMI dongle or an Amazon FireStick to the ZENEC system via the HDMI and AV IN connections, among other things. Both connections are exclusively inputs.

Function	Icon	Operation
HDMI		Tap to call up HDMI mode.
AV IN		Tap to call up the AV IN source.

## FM TUNER

Principle of the FM tuner: Receivable radio stations can be played with the ZENEC UKW RDS tuner. An integrated DSP provides a clearer sound with weaker stations by means of noise interference masking. The radio stations can be stored in a Preset station list.

### Radio Data System RDS







RDS transmits digital additional information in the analogue VHF wavelength, e.g. the station name, the traffic announcements and the alternative frequencies. With a transmitter with multiple frequencies, an automatic changeover to the frequency with the best reception quality takes place if necessary.



### CALL UP FM RADIO SOURCE

Select [Home] → “FM Radio source” via the app overview page. Tap the source symbol to call up the FM Radio source.

The last station to be played is played and the station information such as the station name / transmission frequency is displayed.

Overview of important elements, symbols, operating and display fields on the station information page:

Function	Symbol	Meaning
Station information		Station information page (FM Tuner standard page with station information).
Preset		List of stored stations (station list).
FM settings		FM radio basic settings.
FM / DAB changeover		Tap to switch to the DAB+ tuner source.
Station information		Station name and transmission frequency display.
Cover display		Shows cover image or station graphic or artist info.



Function	Symbol	Meaning
TA		Tap to activate or de-activate the auto switching of RDS traffic announcements
AS		Tap to start FM auto station search

### CALL UP STATION INFORMATION

 Tap to call up the station information.

### CHANGE STATION (SEARCH, PRESETS)

On the ZENEC device:

-  Call up station information.
- < > Tap on right or left arrow key to start the automatic search “up” or “down” or searching in +/- 0.1 MHz transmission frequency steps.  
**or**  
 Wipe with your finger in the display area of the screen to play the previous or next station from the stored station list.

On the steering wheel remote control:





◀ ▶ Press the relevant button on the steering wheel to start the automatic search “up” or “down” or searching in +/- 0.1 MHz transmission frequency steps.

### MANUAL STATION SELECTION

Station selection via frequency.

- Tap on the station frequency field to open the numeric keyboard.
- Enter the required transmission frequency and confirm with [OK].

Overview of important operating and display fields on the station frequency entry keyboard:

Function	Symbol	Meaning
Delete		Tap to delete the entry / number.
Confirm		Confirm frequency entry.
Frequency entry display field		Display of manual frequency entry.
Station frequency field		Station frequency display field of the station that is currently being played.

## FM SETTINGS

All basic settings for the FM Tuner can be made in the FM settings. In order to make the required settings, tap on the respective field or symbol.

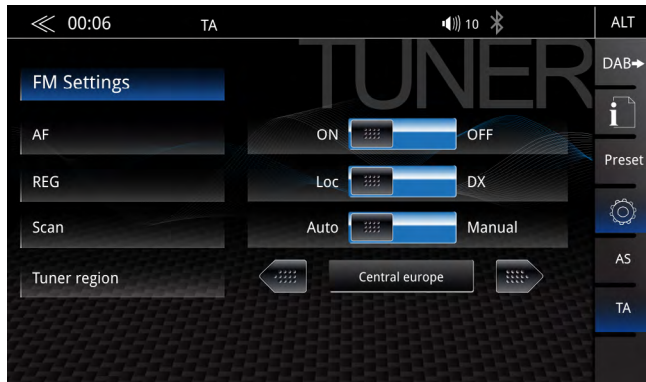

Call up FM settings:

1. Call up FM source.
2. In the Tuner control bar/toolbar, tap on  to call up the FM settings.
3. Make the required settings. The changes are taken over automatically.

Function	Operation
AF	Alternative frequency changeover ON / OFF.
REG	Setting for restricting AF to local region detection.
SCAN	Setting for selecting manual or automatic frequency search.
Tuner region	< > Tap the arrow keys to select the required Tuner region. Possible Tuner region: North Europe, Central Europe (factory setting), South Europe.

## SAVE STATION

18 stations can be stored.

1. Call up FM source.
2. In the Tuner control bar/toolbar, tap on **“Presets”** to call up the presets / station list.
3. Hold down the required storage location to save the current station.

 **INFO:** Short tap to play the stored FM station.

## TA TRAFFIC ANNOUNCEMENTS

ACTIVATE / DEACTIVATE

On the ZENEC device:

Tap the **“TA”** button in the ZENEC operating bar.

## INTERRUPT

During the traffic radio announcement, press one of the TA buttons **“TA”** to cancel the traffic information and announcements.

## DIGITAL RADIO DAB+









Principle of the DAB+ Tuner: Digital transmitters can transmit several programmes and services simultaneously on one frequency. The programme data package of a frequency is referred to as an ensemble. Some transmitters contain additional information, e.g. sports transmitters can transmit different sporting events simultaneously. Depending on the scope of the radio station, additional information, events or also images can be displayed which are transmitted by the radio station.

### CALL UP DAB+ SOURCE

Select [Home]→ “DAB+” via the app overview page. Tap the source symbol to call up the DAB source.

The last station to be played is played and the station information such as the station name, the MOT slideshow and also the current ensemble is displayed.

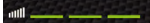
Overview of important elements, symbols, operating and display fields on the DAB information page:



Function	Symbol	Meaning
DAB+ information		DAB+ information page (DAB+ standard page with various items of DAB information).
DAB+ list		DAB+ ensemble and station list display.
Preset		List of stored stations (station list).
DAB+ settings		DAB+ basic settings.
FM / DAB changeover		Tap to switch to the FM Tuner source.
Station information		Station name and ensemble name display.
Slideshow / Cover display		Displays additional information such as the Cover image or station graphic, artist information or events (MOT slideshow).
Signal quality		The DAB signal bar shows the current call up station information signal quality. Green: good signal quality. Yellow: middle signal quality, short interruptions may occur. Red: very weak signal quality, strong interruptions likely.
Scan		Tap to refresh the station list and find more DAB ensembles. Press and hold to delete the station list and start station search.

## CALL UP STATION INFORMATION

 Tap to call up the station information.

## CHANGE STATION

On the ZENEC device:

-  Call up DAB+ information page / main page.
- < >** Operate left or right arrow key to play the previous or next station.  
**or**  
 Wipe to the left or right with your finger in the display area of the DAB standard screen to play the previous or next station from the stored station list (Preset).

On the steering wheel remote control:

**◀ ▶** Press relevant key on steering wheel to play the previous or next DAB station.





## SWITCH ENSEMBLE

On the ZENEC device:



Option 1:

-  To call up DAB+ information page / main page.
- < >** Long press of left or right arrow key to switch to the previous or next ensemble.

Option 2:

-  Call up DAB+ information page / main page
-  Call up DAB+ list.
- Select ensemble and tap , to display the transmitter station list.
- Tap on the required station to play it. A playback symbol  in front of the station shows which station is currently being played.

Overview of important operating and display fields in the DAB+ list:

Function	Symbol	Meaning
Playback indicator		Station currently being played.
Transmitter station list		Tap to display the transmitter station list. Tap again to close the transmitter station list.

 **NOTE:** Some additional service information for the played station and programme is displayed in the MOT slideshow. The availability, content and order depend on the respective radio transmitter.

ALT

## DAB SETTINGS

All basic settings for the DAB Tuner can be made in the DAB settings. In order to make the required settings, tap on the respective field or symbol.

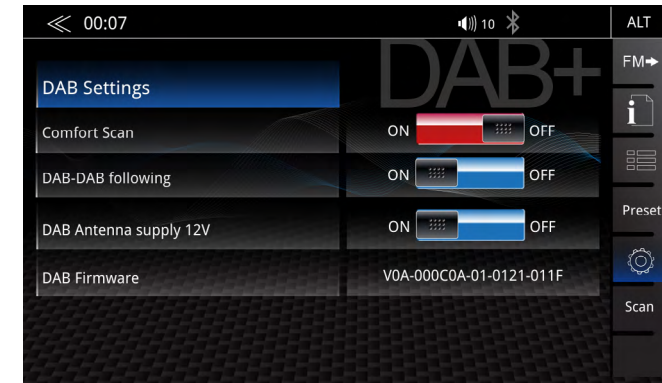

Call up DAB settings:

- Call up DAB+ source.
- In the Tuner control bar/toolbar, tap on  to call up the DAB settings.
- Make the required settings. The changes are taken over automatically.

Function	Meaning
DAB-DAB transmitter following	Tap to switch DAB-DAB transmitter following ON and OFF.
Comfort Scan	Tap to set the automatic channel list updating ON or OFF by each time device starts.
DAB antenna socket 12V supply	Tap to switch the 12V phantom feed for the DAB antenna at the antenna socket ON or OFF.
DAB Firmware	Displays the current DAB Firmware version.

 **NOTE:** DAB-DAB automatic transmitter following.

In the event of poor reception quality, the same transmitter is searched for in a different ensemble and a signal quality check is performed. If the transmitter has better reception in a different ensemble, an automatic switch-over takes place.

## SAVE STATION

18 stations can be stored.

1. Call up DAB+ source
2. In the Tuner control bar/toolbar, tap on “**Presets**” to call up the DAB presets / station list.
3. Hold down the required storage location to save the current station.

 **INFO:** Short tap to play the stored DAB+ station.

## CAMERA

The ZENEC system supports up to two camera systems which can be controlled directly via the screen or via the steering wheel remote control. The camera image of camera 1 switches itself on automatically when reverse gear is selected. You can display and individually configure the parking help lines as a camera image overlay via the extended camera settings within the source. The help lines improve the distance estimation and can be adapted to the size of the vehicle.

### CALL UP CAMERA SOURCE

- Option 1:  Tap the source symbol or the [CAM] sensor button to call up the camera source.
- Option 2: Select reverse gear.
- Option 3: Press the relevant button [CAM] on the steering wheel to call up the camera source.

### SWITCH OVER CAMERA INPUTS



On the ZENEC device:

1. Within the camera source, tap on [Camera 1]  to switch between camera 1 and camera 2.
2. The camera image of the selected camera is displayed.



On the steering wheel remote control:











1. Repeatedly press [CAM] button on steering wheel to switch between camera 1 and camera 2 within the camera source.
2. The camera image of the selected camera is displayed.

### SET AND CONFIGURE CAMERA PARK ASSIST LINES

1.  Tap the source symbol to call up the camera source.
2. Tap on the  symbol in the camera source to call up the extended camera settings.
3. Make required park assist line settings, see table. The changes are taken over automatically.

Overview of important operating and configuration options in the extended camera settings:

Function	Symbol	Meaning
Help line settings		Tap to adjust the lines.
Display	Marker 	Tap to display or hide the lines.

Function	Symbol	Meaning
Line field	Parking lines I 	Display the parking lines, the levels can be changed using the arrows   or press and hold to move directly  .
Close		Tap to close the settings menu.
Together		Tap to reduce the current field.
Apart		Tap to widen the current field.
Up		Tap to pull the current field towards you.
Down		Tap to push the current field away from you.
Basic setting		Tap to set the lines to the basic setting
Manual moving		Press and hold to move the parking lines.

 **NOTE:** To calibrate the help lines, position yourself backwards parallel to the parking space lines in the middle at the beginning of the parking space.

## MISC (general) SETTINGS

Different key assignments can be defined or a required background selected, and the RGB LED colour of the key lighting on the front of the device can be selected in the various or general settings. To configure your ZENEC system in accordance with requirements.

Call up various settings

1. [Home] Call up app list and tap the settings source symbol.
2. Tap on “Misc” to open the various settings.
3. Make the required settings, see table. The changes are taken over automatically.

Overview of important operating and display fields in the misc settings:

Setting	Operation
ALT software button (short press)	<p>Tap to define the function assignment of the ALT button.</p> <p>Possible function: Camera / FM / Setup / iPod / USB / BT / DAB+ / Mute / Voice / Apple Carplay / Android Auto / BT Music / AV-IN / EQ / DISP / HDMI.</p> <p><b>i</b> <b>INFO:</b> Various functions can be stored in the ALT list and called up directly, e.g. sources, navigation, voice control call-up and jumps into the Audio EQ sub-menu. A button that is already occupied with a function can be overwritten with another function.</p>
ALT software button (long press)	<p>Tap to define the function assignment of the ALT button.</p> <p>Possible function: Camera / FM / Setup / iPod / USB / BT / DAB+ / Mute / Voice / Apple Carplay / Android Auto / BT Music / AV-IN / EQ / DISP / HDMI.</p> <p><b>i</b> <b>INFO:</b> Various functions can be stored in the favourite list and called up directly, e.g. sources, navigation, voice control call-up and jumps into the Audio EQ sub-menu. A button that is already occupied with a function can be overwritten with another function.</p>
Volume pop-up	<p>Tap to activate or deactivate the Vol. pop-up.</p> <p>Off: Visual volume display / pop-up deactivated.</p> <p>On: Visual volume display / pop-up activated.</p>
Wallpapers	Tap to change the background image.
Button colour	Tap to adjust hard key illumination.
Device language (OSD)	Tap to change the menu languages of the device.
SWC assignment (analogue teach-in)	Tap on the setting [SWC assignment] to call up the steering wheel remote control teach-in page.
System and key sounds	<p>Tap to activate or deactivate the system and key sound.</p> <p>Off: System and key sound deactivated or muted.</p> <p>On: System and key sound activated (factory setting).</p>
Apple Connectivity	Possible function: Apple CarPlay / iPod USB 1 Port definition for iPod or Apple CarPlay usage.
Microphone	<p>Possible settings: Internal- / external microphone</p> <p>Internal: The microphone in the device is used.</p> <p>External: The external microphone is used. Only possible if fitted and connected.</p>

## AUDIO SETTINGS

You wish to adapt the sound and the volume to your requirements. In the Audio settings you have the possibility of making various audio-related settings such as equalizer / sound playback, subwoofer, run-time correction, audio crossover and more. The sound settings are set comprehensively for all audio sources.

### CALL UP AUDIO EXPERT SETTINGS

1. [Home] Call up app list and tap the settings source symbol.
2. Tap on "Audio" to call up the audio settings.
3. Set „Expert Mode“ to ON.
4. Make the required settings, see following table. The changes are taken over automatically.

Setting	Operation
Quick audio settings	Tap to make quick audio settings. Can be called up by means of a long press of the "HOME" button.
Equalizer / Presets	Tap to set the 16-band equalizer.
Volume	Tap to set the start and source volume.
Balance/Fader	Tap to set the fader and the balance.
Subwoofer	Tap to make subwoofer settings.
Time-Alignment	Tap to make settings.

### MAKE QUICK AUDIO SETTINGS

In the audio quick settings you have the possibility of making all basic settings for the sound pattern in a quick and simple way.

1. [Home] Call up app list and tap the settings source symbol.
2. Tap on "Audio quick settings" to call up the audio settings.
3. Make required settings such as volume, subwoofer volume (gain), balance/fader, bass boost and loudness. The changes are taken over automatically.

Overview of important control fields and settings:

Setting	Operation
Left / right balance	< > Tap the arrow keys to set the front / rear volume distribution. Possible setting range: 15L > 0 < 15R.
Front / rear fader	< > Tap the arrow keys to set the front / rear volume distribution. Possible setting range: 15F > 0 < 15R.
Loudness	<p>Tap to activate or deactivate the Loudness function.</p> <p>On: Loudness function activated.</p> <p>Off: Loudness function deactivated.</p>
Bass Boost	<p>Tap to activate or deactivate the Bass Boost module.</p> <p>On: Bass Boost activated.</p> <p>Off: Bass Boost deactivated.</p>
Subwoofer Gain	< > Tap the arrow keys to set the Subwoofer Gain. Possible setting range: -12 < 0 > +12

**i** **NOTE:** The "blue dot" in the middle of the Balance/Fader field indicates that the volume ratio of the four speakers is the same in the factory-set condition.

## SET EQ PRESETS / PREDEF. AUDIO PROFILE IN THE AUDIO SETTINGS

1. Call up audio settings.
2. Scroll through the audio profile list below to the required audio profile and confirm by tapping. The selected profile is saved.

Setting	Operation
Presets	Tap to call up the audio profile list. Possible profiles: Rock / Classic / Pop / Dance / Soft / Jazz / Flat / User

## CALL UP AND SET EQUALIZER / SOUND SETTINGS

1. [Home] Call up app list and tap the settings source symbol.
2. Tap on "Audio" to call up the audio settings.
3. Set „Expert Mode“ to ON.
4. Then tap on "Equalizer / Presets" to call up the settings.
5.  Hold down the required level slider to slide it up and down to set a value.  
**or**  
Tap the band arrow keys < > to set a value.
6. The set values are automatically saved to the "User" preset.

## SET THE START AND SOURCE VOLUME

1. Call up audio settings.
2. Call up the volume settings.
3. Tap on the required volume to be adapted to your basic requirements in order to call up the volume value list and the possible settings.
4. Choose between last or manually defined (set) volume. Tap on "Last" to deactivate the "Last set volume function" and define a required volume yourself. If the volume is defined manually, the device starts with the manually defined volume value, e.g. the media volume is set to "30", the volume always starts with Vol. "30". The settings are saved automatically.

Overview of important volume and gain settings:

Setting	Operation
Media volume	Media volume configuration. Set: Starts with manually defined volume. Possible scrollable setting range: 0 to 40 Vol. Last: Starts with last set volume before switching off.
BT call volume	BT call volume configuration. Set: Starts with manually defined volume. Possible scrollable setting range: 5 to 40 Vol. Last: Starts with last set volume before switching off.
Ringtone Volume	Phone ringtone volume configuration. Set: Starts with manually defined volume. Possible scrollable setting range: 0 to 40 Vol. Last: Starts with last set volume before switching off.
Voice Volume	Apple CarPlay and Google Android Auto voice assist volume configuration. Set: Starts with manually defined volume. Possible scrollable setting range: 0 to 40 Vol. Last: Starts with last set volume before switching off.

## SET BALANCE AND FADER

1. Call up audio settings.
2. Set „Expert Mode“ to ON.
3. Tap on "Balance/Fader" to call up the Balance/Fader settings.
4. Set required left/right and front/rear volume distribution.

Overview of important operating and display fields in the Bal. / Fad. Settings

Setting	Operation
Left / right balance	< > Tap the arrow keys to set the left/right volume distribution, or slide the blue dot directly to the required position within the cross-hairs. Possible setting range: 15L > 0 < 15R
Front / rear fader	< > Tap the arrow keys to set the front/rear volume distribution, or slide the blue dot directly to the required position within the cross-hairs. Possible setting range: 15F > 0 < 15R

### NOTE:

The "blue dot" in the middle of the Balance/Fader field indicates that the volume ratio of the four speakers is the same in the factory-set condition.

## SET SUBWOOFER

1. Call up audio settings.
2. Set „Expert Mode“ to ON.
3. Tap on “subwoofer” to call up the subwoofer settings.
4. Set required subwoofer phase, gain and low pass crossover frequency, see table. The changes are taken over automatically.

Overview of important operating and display fields in the subwoofer settings:

Setting	Operation
Power	Tap to activate or deactivate the Subwoofer Cinch output. On: Volume in accordance with setting. Off: Mute <b>i</b> <b>INFO:</b> Acts exclusively on the Subwoofer Line-Out.
LPF	< >Tap the arrow keys to set the low-pass filter. Possible settings: OFF 160 Hz/125 Hz/100 Hz (factory setting)/80 Hz/65 Hz
Phase	Tap to set the subwoofer phase. Possible settings: 0° (factory setting) / 180°
Gain	< >Tap the arrow keys to set the Subwoofer Level (GAIN). Possible settings: -12 < 0 > +12

## TIME-ALIGNMENT CORRECTION, GENERAL

Because of the given arrangement of the individual speakers in your vehicle, it may be that the platform depiction is not optimal. The ZENEC time-alignment correction allows you to delay the audio signal to the respective speakers in such a way that you have a central auditory experience.

### SET TIME-ALIGNMENT CORRECTION

1. Call up audio settings.
2. Set „Expert Mode“ to ON.
3. Tap on “time-alignment correction” to call up the time-alignment correction settings.
4. Define central hearing position. Measure the distance from this position to the respective speaker.
5. Set the relevant delay for each speaker, depending on the speaker with the furthest distance or delay. Enter the relevant delay times (distance values) so that all speakers have the same distance. The settings are saved automatically.

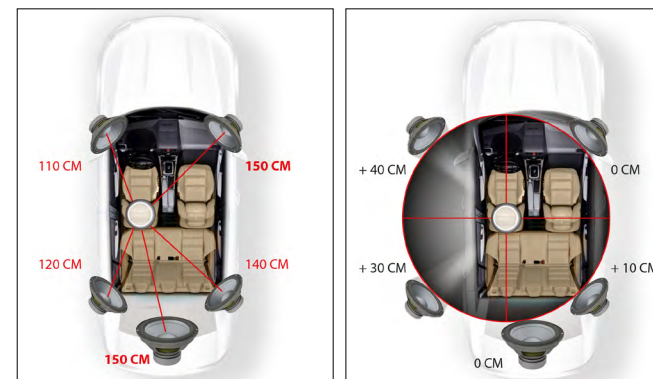

### **i** **NOTE:**

Fine setting can also take place by hearing. You can also set the values by “hearing” depending on the distance from the hearing position to the respective speaker by simply setting the delay of the left front speaker until the middle and balanced position is reached.

Overview of important operating and display fields in the run-time correction settings:

Setting	Operation
Unit	Tap to change the required unit. ms: Time cm: Distance
Speaker	< > Tap the arrow keys to select the required speaker. Possible speakers: FL / FR / RL / RR / SW
Delay	< > Tap the arrow keys to set the required delay time. Possible settings with “ms”: 0.0 < > 20 Info: In steps of 0.1 ms. Possible settings with “cm”: 0 < > 680 Info: In steps of approx. 3,4 cm.

## VEHICLE ASSISTANT SETTINGS (ASSISTS)

Driver assistants are regarded as electronic devices for making driving easier and increasing safety. The optional components which are present or have been retrofitted in the vehicle such as cameras, the new ZENEC Camera and the park assist can be configured in the vehicle assistant settings in order to simultaneously define the interaction of the ZENEC.

### CALL UP DRIVER ASSISTANT SETTINGS

1. [Home] Call up app list and tap the settings source symbol.
2. Tap on "assists" to call up the driver assistant settings.
3. Make the required settings, see table. The changes are taken over automatically.

Overview of important operating and display fields in the driver assistant settings:

Setting	Operation
Park Assist	<p>Tap and hold to move the slider for set the display source of the park assist.</p> <p>Possible settings: Camera / Off Camera: Camera inputs activated (factory setting).</p>
Reverse audio assistant	<p>&lt; &gt; Tap the arrow keys to configure the muting function with the Park Assist active.</p> <ul style="list-style-type: none"><li>• Possible settings: Reduc. Vol. / Mute Audio / Off</li><li>• Reduced volume: The A/V playback volume is reduced or lowered.</li><li>• Mute audio: All volumes are temporarily muted (factory setting).</li></ul>
Reversing camera logic	<p>&lt; &gt; Tap the arrow keys to set the camera switchover and manoeuvring logic.</p> <ul style="list-style-type: none"><li>• Possible camera logic settings: Cam. 1 / Cam. 2 / Cam. 1 + Cam. 2</li><li>• Camera 1: The reversing function is occupied with camera 1 (factory setting).</li><li>• Camera 2: The reversing function is occupied with camera 2.</li><li>• Cam. 1 + Cam. 2: The camera changeover function / park assist Cam. 1 + Cam. 2 mode is activated. Automatic changeover between camera 1 and camera 2.</li></ul>
Reversing camera switch-off delay	<p>&lt; &gt; Tap the arrow keys to set the switch-off delay value for camera 2 when using Cam. 1 + Cam. 2 mode.</p> <ul style="list-style-type: none"><li>• Possible switch-off delay values: 3 sec. / 5 sec. / 7 sec. / Off</li><li>• 3 sec.: The camera is automatically switched off after 3 seconds.</li><li>• 5 sec.: The camera is automatically switched off after 5 seconds.</li><li>• 7 sec.: The camera is automatically switched off after 7 seconds.</li><li>• Off: Switch-off delay deactivated. The camera is switched off immediately.</li></ul>
Multiview	<ul style="list-style-type: none"><li>• Tap and hold to move the slider to enable or disable the Multiview function.</li><li>• Possible settings: On / Off</li><li>• On: Multiview function activated at camera 1 input.</li><li>• Off: Multiview function deactivated at camera 1 input (factory setting).</li></ul>

## DEVICE INPUT SETTINGS

In the input settings you can influence the camera playback parameters of connected reversing cameras such as the contrast and brightness, which can be individually adapted for the camera.

### CALL UP INPUT SETTINGS

1. [Home] Call up app list and tap the settings source symbol.
2. Tap on "inputs" to call up the input settings.
3. Make the required settings, see table. The changes are taken over automatically.

Overview of important operating and display fields in the input settings:

Setting	Operation
Brightness	<p>&lt; &gt; Tap the arrow keys to set the brightness of the camera image.</p> <p>Possible setting range: 0 to +24</p>
Contrast	<p>&lt; &gt; Tap to set the contrast of the camera image.</p> <p>Possible setting range: 0 to +24</p>
Saturation	<p>&lt; &gt; Tap the arrow keys to set the saturation of the camera image.</p> <p>Possible setting range: 0 to +24</p>
Hue	<p>&lt; &gt; Tap the arrow keys to set the hue of the camera image.</p> <p>Possible setting range: 0 to +24</p>
CarPlay - internal Microphone Gain	<p>&lt; &gt; Tap the arrow keys for fine setting of the CarPlay microphone amplification factor..</p> <p>Possible setting range: -6 to +6</p>
CarPlay - external Microphone Gain	<p>&lt; &gt; Tap the arrow keys for fine setting of the CarPlay microphone amplification factor.</p> <p>Possible setting range: -6 to +6</p>

## SYSTEM AND DEVICE SETTINGS

You can change various ZENEC system settings in order to adapt the ZENEC system in accordance with requirements. For example, you can set a password, switch perform a software update or simply load the factory settings and more.

### CALL UP SYSTEM AND DEVICE SETTINGS

1. [Home] Call up app list and tap the settings source symbol.
2. Tap on "System" to call up the system and device settings.
3. Make the required settings, see table. The changes are taken over automatically.

Overview of important operating and display fields in the system and device settings:

Setting	Operation
Software version Info	Display of the current system information and software versions. Tap to display the detailed software information.
Factory setting	Tap and confirm to load the factory settings and reset the ZENEC system to the delivery condition.
Software update via USB	Tap and confirm to perform a software update. <a href="https://www.zenec.com/support/software-updates/z-e3771/?lang=en">https://www.zenec.com/support/software-updates/z-e3771/?lang=en</a>
Password function	Tap to activate or deactivate the password function. Off: Password function deactivated (factory setting). On: Password function activated.
Password	Tap to store a password.
Export to USB	Tap and confirm to save your profile settings in the ZENEC system on an external data medium (USB) with FAT32 formatting.
Load from USB	Tap and confirm to load your saved profile settings from an external data medium (USB) to the ZENEC system.

## TIME AND DATE SETTING

The ZENEC system has several synchronisation sources which can be set in the time and date settings. You can also set the time format, change the displayed time and also select the time source (system time, DAB time or navigation time) for the time display.

### CALL UP TIME AND DATE SETTING:

1. Call up settings.
2. Tap on "System" to call up the time and date settings.
3. Make the required settings, see table. The changes are taken over automatically.

Overview of important operating and display fields in the time and date settings:

Setting	Operation
Time sync. Mode	< > Tap the arrow keys to change the time synchronisation source. Possible sources: DAB / GPS / RTC DAB: Automatic time synchronisation via DAB+ (factory setting). The time and date cannot be changed manually, which is why the fields are greyed out or cannot be selected. The time-zone and format can be changed. GPS: Automatic time synchronisation via GPS-Data. The time and date cannot be changed manually, which is why the fields are greyed out or cannot be selected. The time-zone and format can be changed. RTC: Automatic time synchronisation via internal system quartz. The time of day format, the time format, the time-zone and the date can be changed manually when doing this.
Select hour format	Tap to select 12 / 24 hour time format.
Change time of day	Tap to change the time of day manually.
Change date	Tap to change the date manually.

#### NOTE:

"RTC" means real-time clock. The RTC is a system-internal quartz time signal.

A manual time setting and date is only possible if RTC has been selected as the synchronisation source. With the two "DAB" and "GPS" sources, the correct hour format, date and the time of day are taken over and synchronised automatically.

## TFT DISPLAY SCREEN SETTINGS

The require display screen brightness can be individually adapted to your requirements in the display screen settings. You can set your display screen brightness and a DAY / NIGHT brightness changeover on your ZENEC system.

### CALL UP TFT DISPLAY SCREEN SETTINGS

1. Call up settings.
2. Tap on "TFT display screen" to call up the TFT display screen settings.
3. Make the required settings, see table. The changes are taken over automatically.

Overview of important operating and display fields in the display screen input settings:

Setting	Operation
Dimm mode	Tap to select the brightness actuation.  Possible sources: Auto / Day / Night Auto: The brightness setting takes place using the vehicle illumination cable (factory setting). Depending on the vehicle, the brightness of the display can also be influenced via the instrument lighting with the low beam switched on. Day: The brightness setting is permanently controlled by the day mode. No day and night switching. Night: The brightness setting is permanently controlled by the night mode. No day and night switching.

Setting	Operation
TS brightness, day	< > Tap the arrow keys to set the day value. Possible setting range: 0 to 20
TS brightness, night	< > Tap the arrow keys to set the night value. Possible setting range: 0 to 20

TS Auto Standby	<p>&lt; &gt; Tap the arrow keys to activate or deactivate the automatic display screen switch-off.</p> <p>Possible switch-off values: 15 sec. / 30 sec. / 60 sec. / Off            15 sec.: The standby mode is activated after 15 seconds and the display screen is automatically switched off.            30 sec.: The standby mode is activated after 30 seconds and the display screen is automatically switched off.            60 sec.: The standby mode is activated after 60 seconds and the display screen is automatically switched off.            Off: TS Auto Standby deactivated (factory setting).</p> <p><b>i INFO:</b> Tap on the TFT display screen, one of the buttons or perform a required operating function to terminate the standby.</p>
-----------------	--

**i NOTE:**  
You can set the display screen brightness in three stages (100% → 50% → 0%) using the Alternative (ALT) button if this has been occupied with the DISP function.

## SOFTWARE VERSION

In the ZENEC device settings under Software Version Info you can see the currently installed software version, together with version information about MCU, System OS, APP, Tuner Database and Short-Version [Settings] → [System] → “Software Version Info”.

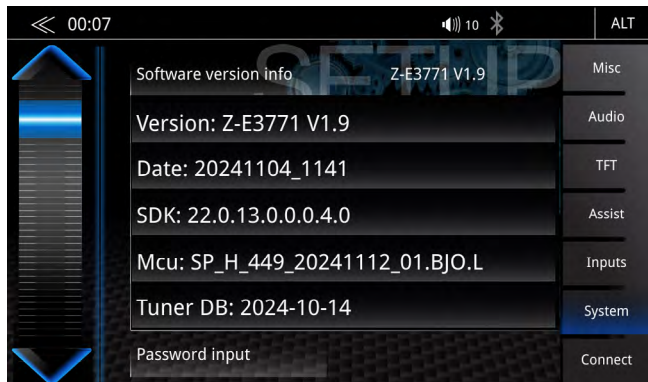

### CALL UP DETAILED VERSION INFORMATION

1. [Home] Call up app list and tap the settings source symbol.
2. Tap on “System” to call up the system settings.
3. Tap on “Software Version Info” to call up the detailed version information.

## PASSWORD PROTECTION

Protect your ZENEC system. With the simple ZENEC password protection, the user can define a password which applies for the overall system in the settings. A password (Abb.: PW) is a sequence of characters which is used to control access to your ZENEC system.

### CREATE AND ACTIVATE PASSWORD PROTECTION

1. Call up system settings.
2. Open the system settings.
3. Tap to “Password input” to call up the entry keyboard.
4. Enter required password (Standard password: 12345).
5. Confirm password by entering it again and confirm with OK. The required password is accepted and stored.
6. Tap on “Password Function” to activate the password.
7. Password protection has now been activated.

**i NOTE:**  
If you protect your ZENEC system with a password, please ensure that the access to this password is safeguarded for subsequent use. Blocking of the ZENEC system is billable, and can only be carried out by ZENEC service.

## NOTES CONCERNING INSTALLATION

### ⚠ CAUTION:

- The ZENEC system should be installed by an authorised retailer. Specific knowledge and tools are required for installation. Incorrect installation can damage the vehicle and the ZENEC system.
- Fault-free operation can only be guaranteed if you use the equipment supplied, or the optional ZENEC original accessories. The ZENEC system and original accessories must never be modified or altered in any way. Incorrect handling can damage the vehicle and the ZENEC system.

### i NOTE:

- The ZENEC Z-E3771 is equipped with an integrated DAB+ receiver. To use it, you need a suitable DAB antenna (not supplied), which must be connected to the ZENEC system.
- If the target vehicle is already fitted with an original DAB antenna, it can still be used in conjunction with the ZENEC system.
- ZENEC system software updates are installed using a USB data stick. During installation, you must therefore ensure that the USB connection of the ZENEC system is also accessible later (installation of USB extension or USB hub).
- If you have any questions or problems with the ZENEC system, please contact the retailer from whom you purchased it.

## DISASSEMBLY AND PREPARATION

### i NOTE:

1. Remove the ignition key and leave it outside the vehicle for the duration of installation.
2. wait for approximately 2-3 minutes until all vehicle systems have shut down completely before starting the disassemble the original device.
3. Start to disassemble the original device.
4. Do not switch the ignition back on until all the points in the assembly manual have been completed and the ZENEC system has been fully installed.

### i NOTE:

- Ensure that all connectors on the rear of the device have sufficient clearance and are not kinked.
- Plug-in connections without a securing mechanism must also be secured with insulating tape.

## OVERVIEW OF INSTALLATION AND CONNECTION ACCESSORIES

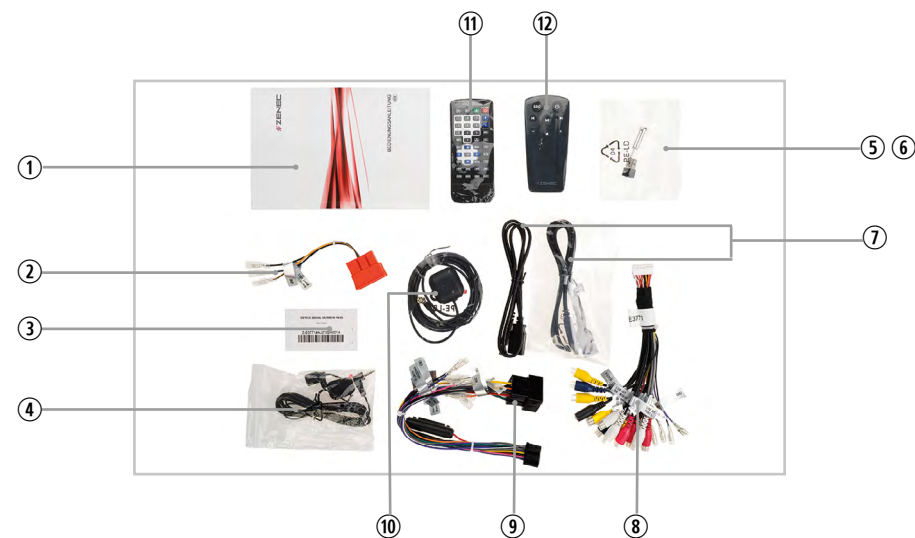

No.	Item	Quantity
1	Main device user manual	1
2	SWC analogue adapter (key 1, key 2 and GND)	1
3	Serial number sticker	1
4	Bluetooth microphone with mounting clip	1
5	USB-C to USB-A adapter for Smartphone usage	1
6	FM antenna adapter ISO/DIN	1
7	USB extension cable	2
8	24-Pin connecting cable (Mic, CAM / Mview, IR-IN, eCall Mute, Analogue SWC-IN etc.)	1
9	20-Pin ISO-DIN main harness	1
10	GPS antenna with double-sided adhesive pad for installation	1
11	Universal remote control	1
12	Motorhome "Maxi" remote control	1

# Z-E3771 CONNECTION DIAGRAM

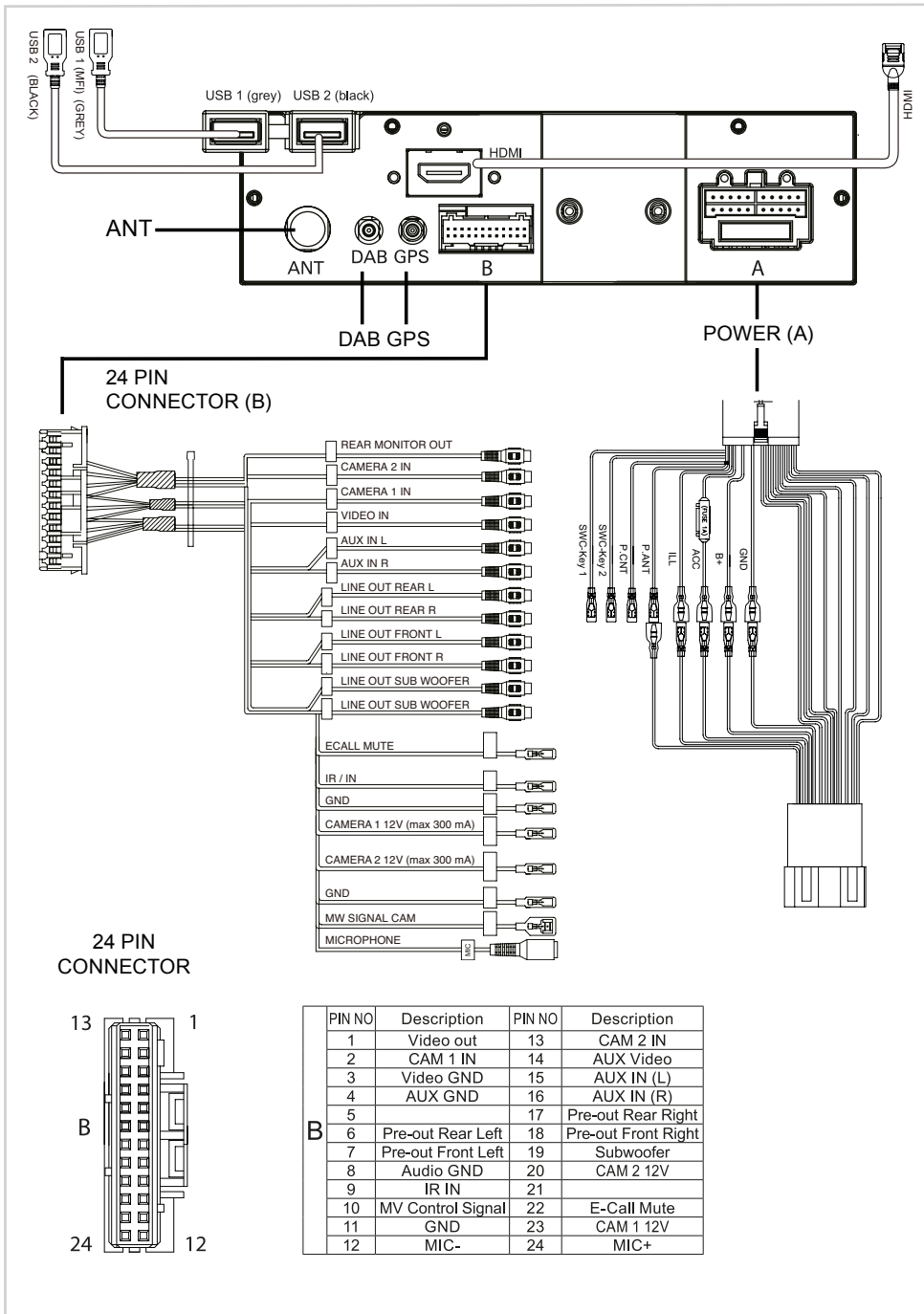

# Z-E3771 CONNECTION DIAGRAM (page 2)

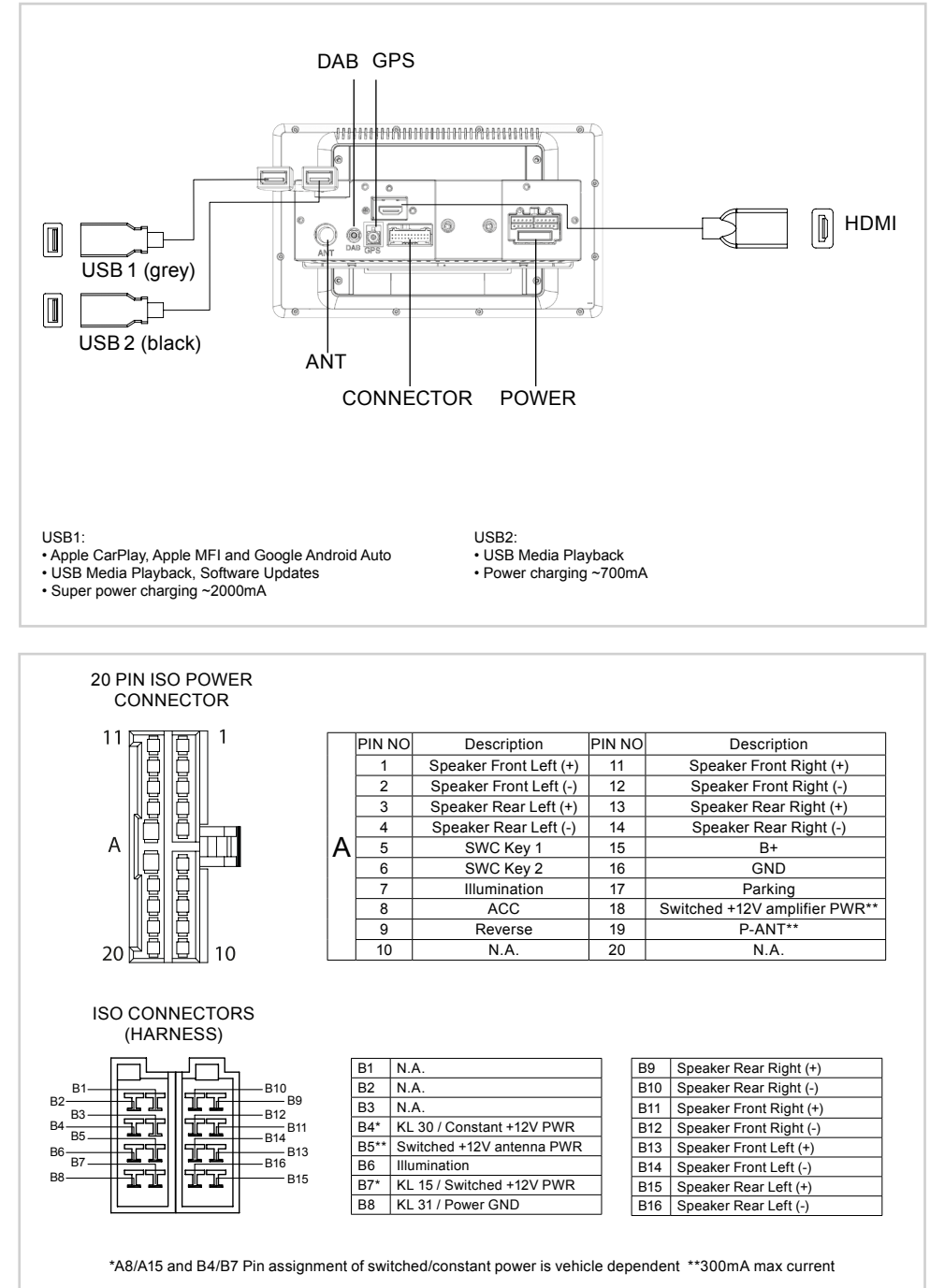

---

## ABBREVIATIONS

Abbreviation	Description
A2DP	Manufacturer-encompassing Bluetooth® technology which makes it possible to transmit audio signals wirelessly (Advanced Audio Distribution Profile)
AF	Alternative Frequency
CAN-Bus	The CAN bus (Controller Area Network) is a serial bus system for communication between the control units in a vehicle.
CP	Apple CarPlay
DAB/DAB+	Transmission standard for terrestrial reception of digital radio (Digital Audio Broadcasting)
DSP	The digital signal processor is used to process digital signals (e.g. audio or video signals).
EQ	Equalizer
FAT32	Formatting format for digital data media (File allocation table 32-bit)
UKW/FM	Transmission standard for terrestrial reception of ultra high frequency analogue radio (UHF)
AAP / GAA	Google Android Auto
GPS	Global navigation satellite system for position determination (Global Positioning System)
GSM	Global mobile radio network, a standard for fully digital mobile radio networks (Global System for Mobile Communications)
ID3 tag	An ID3 tag is an information format (metadata) which is included in the audio files with MP3 format.
micro SD	Very compact Flash memory
REG	Regional station
SSP	Secure Simple Pairing (for Bluetooth devices)
TA	Traffic announcements from selected RDS transmitters
USB	The USB connection is a serial bus system for connecting between devices (Universal Serial Bus).
SWC	Steering wheel remote control

---

## WARRANTY

### Which products are covered by ZENEC's limited manufacturer warranty?

The limited manufacturer warranty (the "Warranty") applies to ZENEC products purchased from an authorized dealer by end customers in the European Economic Area or Switzerland ("Territorial Scope").

### What is the validity period of the ZENEC warranty?

Under this warranty, ZENEC guarantees for a period of 2 years, that the product is free from material and/or workmanship defects at the time of the original purchase. This 2-year period commences on the date of the original purchase as per the original invoice or till receipt. If you have purchased the product as a consumer, and the defect is identified within the first six months after the original purchase (see above), we will assume that the defect already existed at the time of purchase.

### Who can claim under the warranty?

ZENEC grants the limited warranty exclusively to natural persons who purchased the relevant product primarily for personal use.

### What is covered by the warranty?

ZENEC guarantees that the product is free from material and/or workmanship defects at the time of the original purchase. ZENEC does not, however, provide a warranty that covers every defect and damage that may occur. It only covers the hardware components of the device, and not the software used with the device, regardless of whether this was provided by ZENEC or third-party providers. The warranty therefore does not cover the following cases, in particular:

- normal wear and tear (such as to surfaces and protective coverings);
- superficial damage, such as scratches, dents, and damaged plastic, worn or mechanically defective connections;
- misuse, including any treatment resulting in physical or superficial damage such as a cosmetic defects to the product;
- damage caused by connecting or using the product for anything other than its intended purpose, or failure to observe the model-specific operating and/or installation instructions;
- installation or use of the product contrary to the applicable technical standards or the safety regulations in the country in which the product is installed or used;
- damage caused by unauthorized repair attempts, or attempted repairs by someone other than an authorized ZENEC service partner;
- damage caused by modifications to the product not expressly authorized by the manufacturer;
- damage caused by malicious software ("Software Viruses") or by using software that was not supplied with the product or has been incorrectly installed;
- use of third party vendor software programs for editing, modifying, adapting, or extending ZENEC's authorized software components which are run on the product;
- use of third-party firmware/operating system software
- damage caused by liquids or chemicals of any kind, and/or excessive temperatures, moisture, or damp;
- accidents, falls or other such effects of extreme accelerating forces;
- damage caused by lightning strikes, electrostatic discharges, incorrect operating voltage, water, fire, force majeure, inadequate ventilation or other reasons for which ZENEC is not responsible;
- damage caused by using the device outside of the defined specifications;
- damage caused by using the product with other systems or devices which are not designed to be used with this product;
- adjustments or modifications without the prior written approval of ZENEC, including product upgrades which extend beyond the specifications or characteristics described in the operating instructions;
- modifications to the product for the purpose of adapting it to national or local technical norms or safety standards in countries for which the product has not been expressly designed or manufactured;
- using service or spare parts which were not manufactured or distributed by ZENEC;
- using the product in connection with accessories which are not approved for use with this product;

ZENEC also does not give any guarantee (expressly, implicitly, statutorily, or otherwise) for the quality, performance, accuracy, reliability or suitability of the product for a particular purpose except as described for us, nor the software/firmware installed on the device in the factory.

A warranty can also not be provided if the model/serial/UUID product number on the product has been modified, deleted, defaced, or removed. The same applies if the till receipt or invoice is incomplete and/or illegible when presented.

### Is ZENEC liable for other defects or damage?

ZENEC will only repair or replace products if they are covered by the terms of this warranty. ZENEC is not liable for any material or intangible losses or damage such as the purchase price, loss of profits, loss

of revenue, loss of data, immaterial damage or damage resulting from non-availability of the product or its associated components which arises directly or indirectly under this warranty or otherwise in relation to products or services. This also applies to losses or damage due to impairment or operational failure of the product, or devices associated with it, caused by defects or the non-availability of the product while it is with ZENEC or the service partner, as well as to periods of downtime and business interruptions. ZENEC also does not accept any liability for transport-related risks such as the loss or destruction of the product in connection with the fulfilment of the warranty.

This disclaimer applies to losses and damage irrespective of the legal basis, particularly on the because of negligence, other non-permissible conduct, breach of contract, express or implied guarantees and strict liability (even if ZENEC or its service partner has been advised of the possibility of such damage occurring).

If these disclaimers are prohibited or limited under the applicable law, ZENEC shall limit its warranty and liability to the extent that is permissible in accordance with the applicable regulations. For example, some national laws prohibit the exclusion or limiting of damages payable in connection with negligence, gross negligence, willful wrongdoing, fraud, and other similar actions. For the duration of this warranty, all liability that cannot be excluded completely will be limited to the extent permissible under the applicable law. Liability under this warranty is limited to the purchase price for the product. If the applicable law only permits higher limits on any liability, this higher limitation shall apply.

### How do I exercise my warranty rights?

If you wish to exercise your entitlements under this warranty, please contact the authorized dealer from whom the product was purchased, and present it with the original copy of the till receipt or invoice. Do not return any products to ZENEC directly, otherwise our warranty obligations cannot be fulfilled. You will find the name of the relevant dealer or vendor on your proof of purchase.

Defective devices sent by the authorised dealer to the service centre must also be accompanied by any accessories which have a logical connection to the observed fault. This means, for example, the navigation package on an SD or microSD card which was supplied or purchased with the device, if problems or functional defects have been observed in connection with the navigation function.

### How will ZENEC fulfil its warranty?

ZENEC or its service partner will have the choice of either repairing or replacing the product or its defective parts covered by the warranty, and assume the material and labour costs at its own discretion and in accordance with the prevailing conditions.

Repairs under the warranty must be carried out by ZENEC itself or its authorized service partner. Repaired or replaced products may contain new and/or refurbished components and devices. Replaced components shall become the property of ZENEC.

### Will I incur any costs in connection with the warranty service?

ZENEC will cover the material and labour costs in connection with its warranty service. The warranty holder is responsible for the cost of shipment and shall bear the risks associated with the shipment (see above). If the product is found to be operating faultlessly, or there is no warranty entitlement because the warrant period has expired or for any other reason, ZENEC or its authorized service partner shall be entitled to charge a flat-rate investigation charge of €30.00.

### Does this warranty affect my statutory or contractual rights?

This warranty is a voluntary service provided by ZENEC which is an extension of your statutory rights. As a consumer, you remain fully entitled to your statutory rights, such as the statutory guarantee. This warranty also has no effect whatsoever on your contractual rights against the vendor. You may continue to exercise these rights in full.

## Operating frequency / maximum transmission power

This is a class B product (Wi-Fi) or class 1 product (Bluetooth), via the integrated, combined Wi-Fi/Bluetooth module.

## Wi-Fi

Wi-Fi standard: 2.4G: IEEE802.11 b/g/n, 5G: IEEE802.11 a/n/ac  
Transmission range: Up to 100 m  
Transmission frequency bands: 2.4GHz + 5GHz  
Transmission power: 17 dBm/60 mW max., 10 dBm/10 mW min.  
Transmission profiles: Wi-Fi-AP (access point, WiFi station)

## Bluetooth

Bluetooth standard: v5.0 + EDR  
Transmission frequency band: 2402 MHz ~ 2480 MHz  
Bluetooth class: Class 1  
Transmission power: 9dBm / 9 mW

## Information concerning radio frequency exposure

This device fulfils the EU requirements (2014/53/EU Article 3.1a) for the limitation of exposure of the general public to electromagnetic fields in terms of health protection.

Do not use this device in locations in which wireless devices are not permitted.

ZENEC cannot guarantee that no accidents or damage will occur if the device is used incorrectly. Use this product with care and at your own risk.



## Recycling instructions

This product bears the symbol for selective sorting of used electrical and electronic equipment (WEEE). This means that the product must be handled in accordance with European directive 2012/19/EU in order to be recycled or disassembled in order to minimise the effects on the environment. The user has the choice of handing over his product to a competent recycling organisation or to the retailer, if a new electrical or electronic device has been purchased.

EU conformity declaration



EU Regulation 2023/988 ALL  
Info on general product safety



Manufacturer: ACR AG · Bohrturmweg 1 · CH-5330 Bad Zurzach · Switzerland

EU legal representative: ACR S & V GmbH · Industriestraße 35 · D-79787 Lauchringen · Germany · [www.zenec.com](http://www.zenec.com)

ACR Brändli + Vögeli AG hereby declares that the ZENEC-Z-E3771 is CE compliant – the EU conformity declaration can be accessed at the following Internet address: <https://www.zenec.com> (see link "Product Conformity Documents" in footer area).



MADE IN CHINA



UK AR - authorities only  
ProductIP (UK) Ltd.  
8, Northumberland Av.  
London WC2N 5BY  
[ukar@productip.com](mailto:ukar@productip.com)

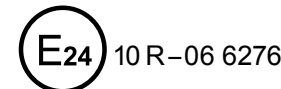



Device Software Version / Software Update

<https://www.zenec.com/support/software-updates/z-e3771/?lang=en>

© Copyright 2025

RevD / Editorial deadline: Q2-2025

English

Manufacturer: ACR AG · Bohrturmweg 1 · CH-5330 Bad Zurzach · Switzerland

EU legal representative: ACR S & V GmbH · Industriestraße 35 · D-79787 Lauchringen · Germany